

STAR WARS
**X-WING
ALLIANCE**



MOC-102441
YT-2000 FREIGHTER

OTANA
1508
pcs/pzs



PREVIEW

DESIGNED BY



APOCRYPHEA

PREFACE

My Name is Jonathan, and I am a French-Canadian AFOL with a love for Star Wars, and more specifically, it's ships.

I now hold a career in the video game industry as a Game & Level Designer.

That being said, I wouldn't be where I am today if it were not for all 3 of these things this project centers around : Video Games, Star Wars and LEGO. 3 of my greatest influences and passions colliding into another project!

Following the success of my YT-2400 Outrider Build (MOC-97338), I've had many requests to continue down the YT Freighter line, and more specifically, the YT-2000 which is featured in the old X-Wing Alliance video game. With all these Corellian ships under my building experience, I figured, why not?

It was certainly a challenge to build a ship that I had no initial attachment to. But after some lengthy research, I mustered my determination and poured my passion into this project with the goal of offering the best possible product that could be done - And this might be my finest project yet!

Like most of my projects, this ship does not have an official LEGO build, and I also designed this one with the same criterias you'd expect from a real product. Quality, Accuracy, Solidity, Stability, Techniques and Optimization. It even has full play features and opens up like the Falcon(s)!

I hope you enjoy this build as much as I did undertaking its creation!



Mon nom est Jonathan, et je suis un Canadien Français Fan de Lego Adulte avec un amour pour Star Wars, et plus spécifiquement, les vaisseaux de ceux-ci!

Je détiens maintenant une carrière dans l'industrie du Jeu Vidéo en tant que Concepteur de Jeu & Niveaux.

Cela-dit, je ne serais pas ou j'en suis aujourd'hui si ce n'était pas des 3 choses auquel ce projet focus: Les Jeux Vidéo, Les LEGOs et Star Wars. 3 de mes plus grandes influences et passions réunis dans un autre projet encore!

Suite au succès retentissant de mon projet YT-2400 Outrider (MOC-97338), j'ai reçu énormément de requêtes pour continuer la ligne de vaisseaux YT, plus spécifiquement, le YT-2000 qui est en vedette dans le jeu vidéo X-Wing Alliance. Avec tous ces vaisseaux Corellien dans mon expérience, je me suis dit, pourquoi pas?

C'était certainement éprouvant de concevoir un vaisseau dont je n'avais aucune nostalgie ou attachement initialement. Toutefois, après de longues études, j'ai pris ma détermination et ma passion en main dans le but d'offrir le meilleur produit possible - En fait, c'est peut-être mon projet le mieux réussi!

Comme plusieurs de mes projets, ce vaisseau n'a pas de construction officielle LEGO, donc j'ai conçu ce projet dans la même optique et critères que vous pouvez vous attendre d'un vrai produit LEGO: Qualité, Fidélité, Solidité, techniques et optimisation. Il y a même toutes les caractéristiques de jouabilité et s'ouvre comme le Faucon!

J'espère que vous aimerez cette construction autant que j'ai eu de plaisir à le concevoir!



Cheers! Au Plaisir!

Jonathan D.M
// APOCRYPHEA



ORIGINS

The **YT-2000** is a Freighter/Transport ship of Corellian Design, and is of the same series/origins as the Infamous Millennium Falcon (A YT-1300 model).

The ship made it's first appearance in the **Star Wars: X-Wing Alliance** video game which first released in **1999**. The fourth installment in the X-Wing / TIE simulator video games, this game in particular was conceived with the mindset of having a stronger storytelling aspect, which was lacking in the previous entries.

That said, the **Otana** is the ship of the Protagonist's family, the Azzameens, who are owners of a trading and transport company which eventually become entangled in the Empire and Rebel Alliance's conflict. The Otana is in essence the 'home' of the Protagonist, **Ace Azzameen**.

Due to the canon continuity revision in 2014, the YT-2000 and the game became part of the Legends portion of the Star Wars universe.

The model of the ship, however, was reintroduced to the official canon in a **Star Wars Rebels** comic in 2016, under the name of the Stellar Sun. It is also mentioned in the *YT-1300 Millennium Falcon Owners' Workshop Manual*.



ORIGINES

Le **YT-2000** est un vaisseau Cargo/Transport de design Corellien, de la même series/origines que le fameux Faucon Millénaire (Qui est un modèle YT-1300).

Ce vaisseau fait sa première apparition dans le jeu vidéo **Star Wars: X-Wing Alliance** qui parut en 1999. Le quatrième de la série de jeu simulateurs X-Wing / TIE Fighter, ce jeu en particulier fut conçu dans l'optique d'y intégrer une plus grande importance à l'histoire, ce qui manquait grandement dans les instances précédentes.

Ceci-dit, le **Otana** est le vaisseau de la famille du protagoniste, les Azzameen, qui sont dirigeants d'une compagnie de transport et de commerce, qui éventuellement deviennent entremêlé au conflit entre l'Empire galactique et l'Alliance Rebelle. Le Otana est essentiellement la résidence du protagoniste, **Ace Azzameen**.

Due à la révision de la continuité canonique de l'univers Star Wars en 2014, le YT-2000 et le jeu font partie de la continuité des légendes.

Le modèle du vaisseau, toutefois, fut réintroduit au canon officiel en 2016 avec la parution d'une bande dessinée dans la série **Star Wars Rebels**, sous le nom du Stellar Sun. Il est aussi mentionné dans le Livre *YT-1300 Millennium Falcon Owner's Workshop Manual*.





SPECIFICATIONS

The YT-2000 transport was a model of Freighter in the YT-Series. It is saucer shaped with a central cockpit wedged between two mandibles. This nacelle section would double as a lifeboat in case of emergency and could break away from the ship clearly.

This model had superior features to most civilian freighters; heavier shields, two double laser cannons, a substantial cargo capacity of 115 metric tons (15 more than the previous YT-1300 model) and equipped with class 2 hyperdrive (amongst the base) with a backup system. It's streamlined design and layout allowed for great customization and modifications to suit any owner's needs.

Le transport YT-2000 est un modèle de vaisseau cargo de la série YT. La section principale en forme de soucoupe as un cockpit logé au milieu entre deux mandibules. Cette section nacelle peut se détacher du vaisseau facilement en cas d'urgence et servir de pod de sauvetage.

Ce modèle as des caractéristiques supérieures à la plupart des vaisseaux civils commun; des boucliers lourds, des canons lasers doubles, une capacité cargo substantielle de 115 tonnes métriques (soit 15 de plus que le modèle YT-1300).

Manufacturer: Corellian Engineering Corporation Speed: 800 KM/H
Length: 29.4M

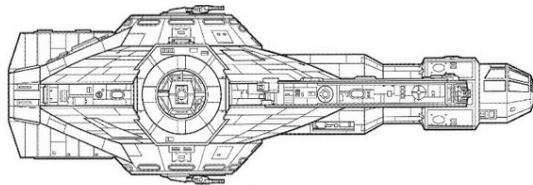
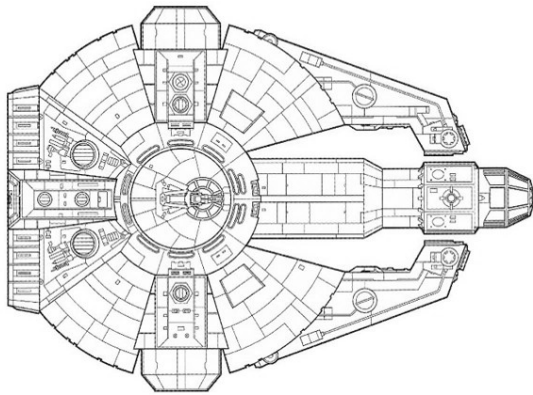

CEC YT-2000 LIGHT FREIGHTER

THE YT-2000 TRANSPORT WAS DESIGNED TO BE A DIRECT IMPROVEMENT OVER THE YT-1300, BUT IT ONLY SAW A LIMITED PRODUCTION RUN. ITS BASIC DESIGN WAS SIMILAR TO THE YT-1300 WITH ITS CENTRALLY-PLACED COCKPIT AND SYMMETRICAL DESIGN, WHILE THE REST OF THE SHIP RETURNED TO THE MAINLINE DESIGN OF THE YT-1300. THE HEAVY ARMAMENT AND SHIELDS, COUPLED WITH ITS SPEED AND MANEUVERABILITY, CAUSED MANY IMPERIAL OFFICIALS TO VIEW THE YT-2000 BEING MARKETED AS A 'CIVILIAN' SHIP WITH SUSPICION.



LENGTH: 29.4 METERS
WIDTH: 19.0 METERS
HEIGHT: 10.0 METERS

CORELLIAN ENGINEERING CORPORATION YT-2000 TRANSPORTER

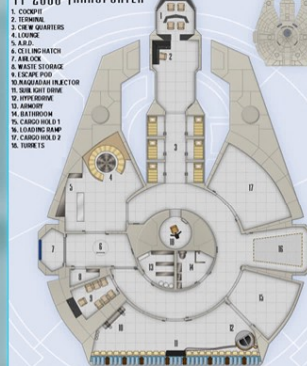

1. COCKPIT
2. ENGINE
3. CREW QUARTERS
4. LIVING
5. A.H.Q.
6. C.O. QUARTERS
7. AIRLOCK
8. WREST STAIRCASE
9. T-SCAN POD
10. HULL REPAIR FACTORY
11. SUNK SHOT DRIVE
12. HYPERDRIVE
13. BARRACKS
14. BATHROOM
15. CARGO HOLD 1
16. LOADING RAMP
17. CARGO HOLD 2
18. TOWERS



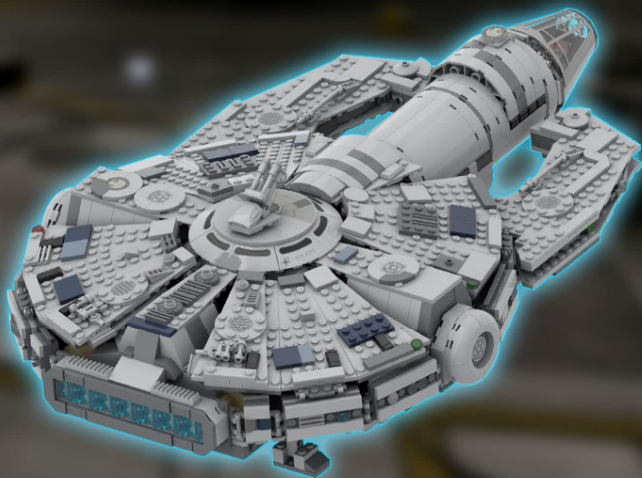

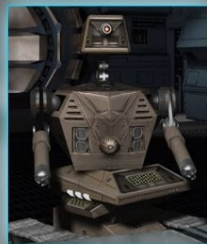
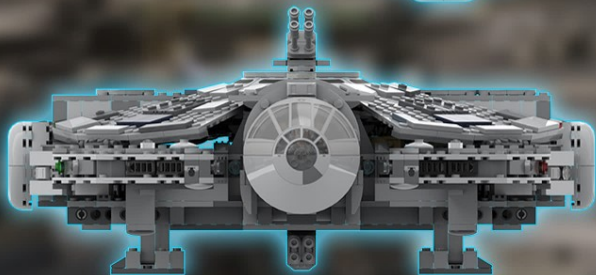
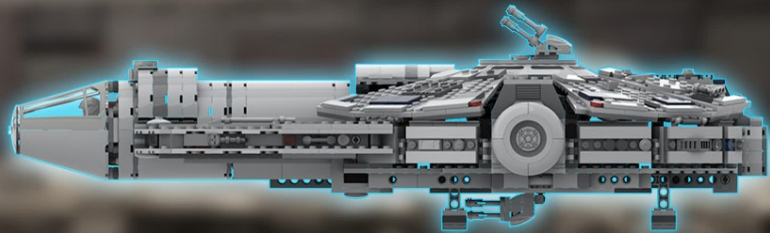
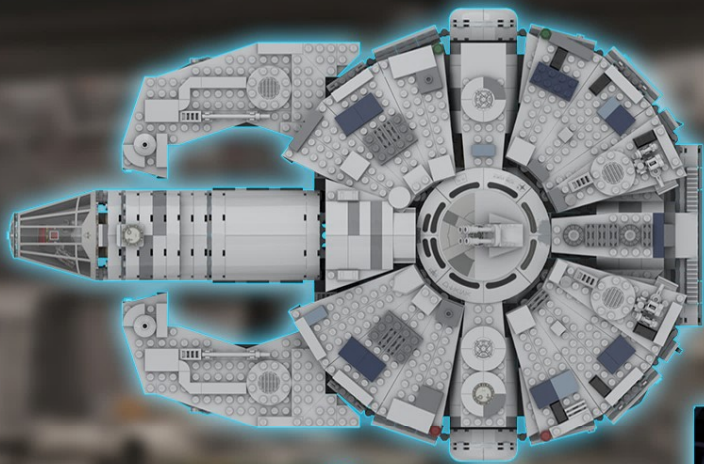

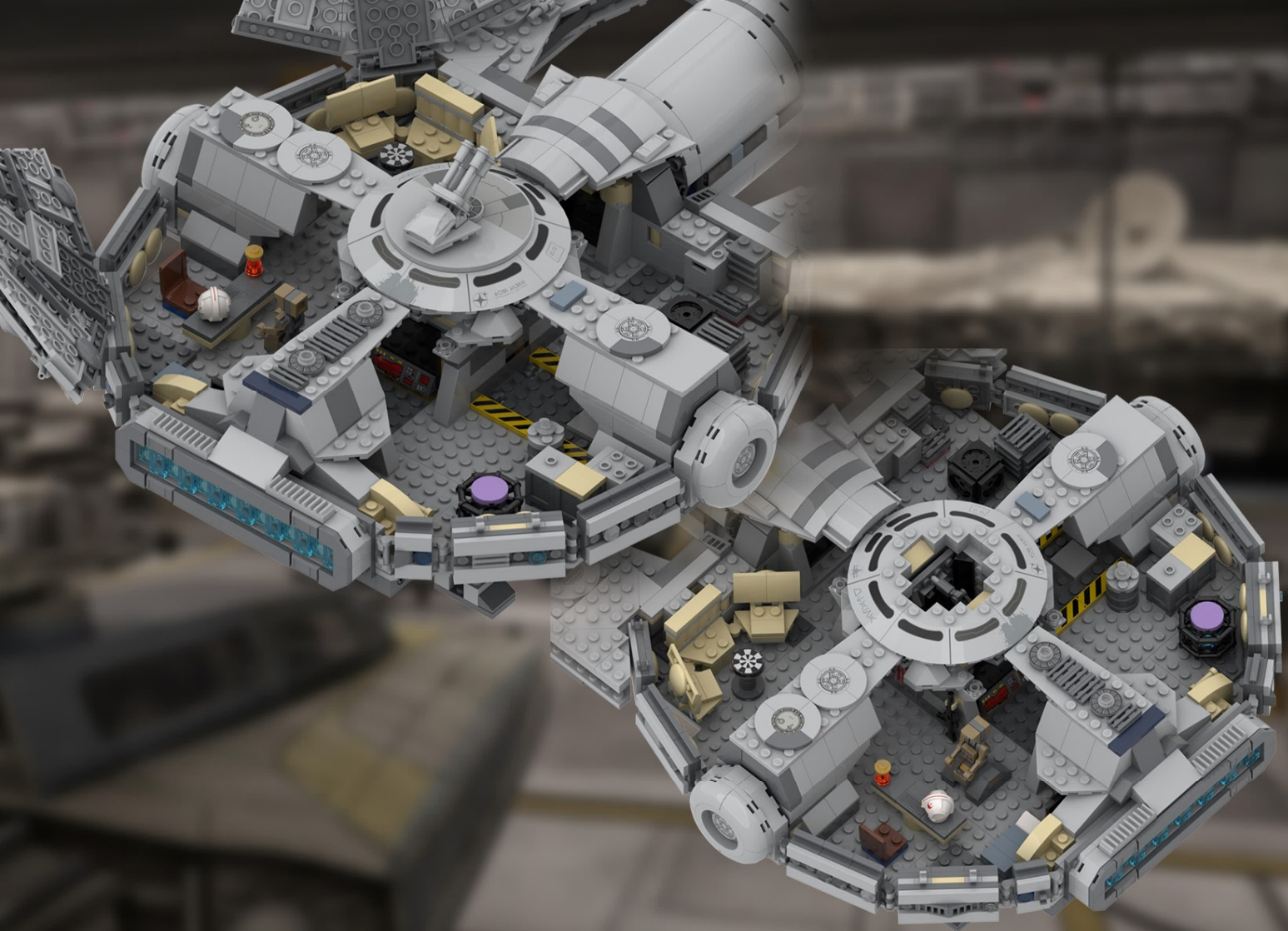

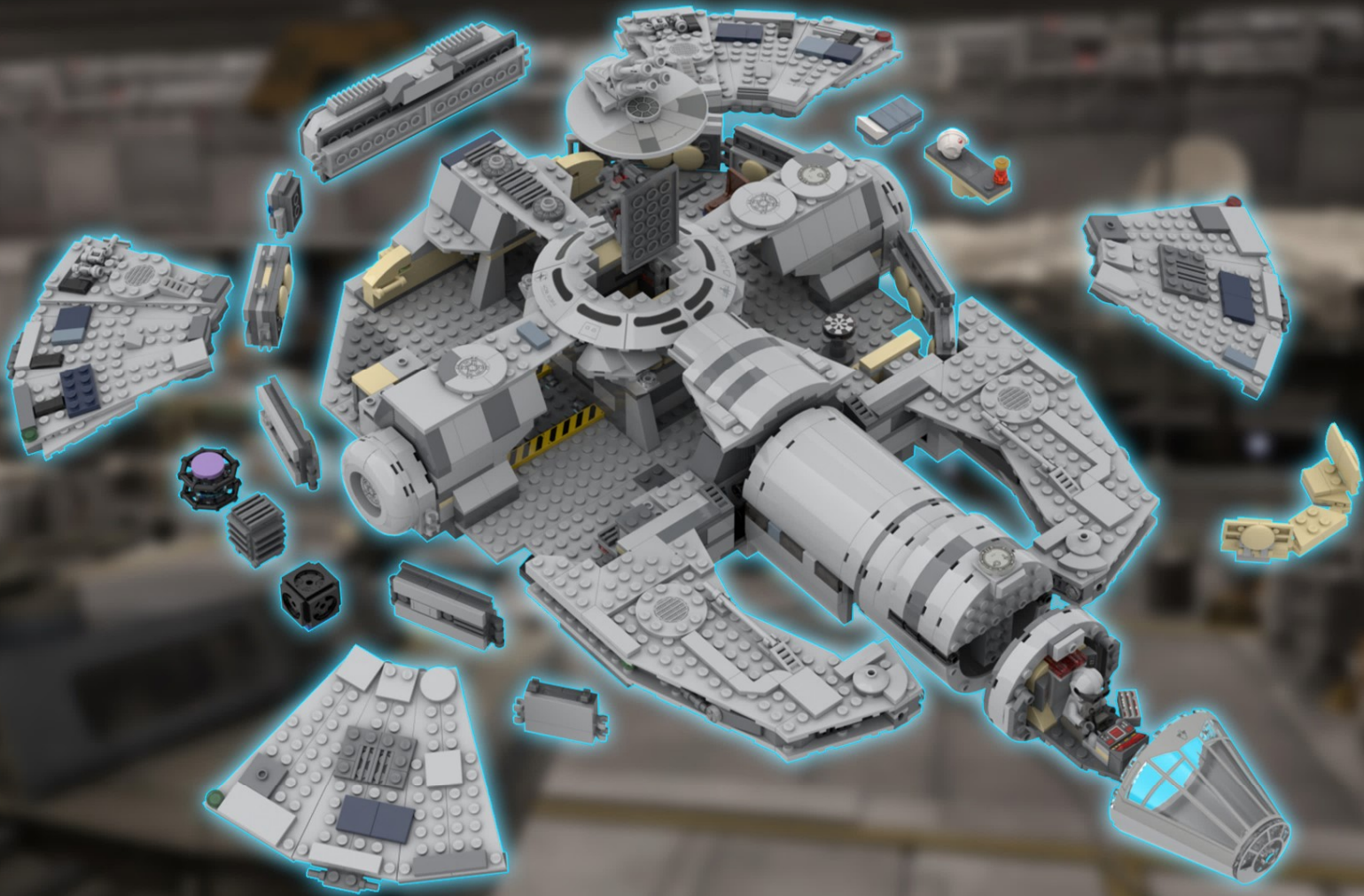

New to the world of MOCs? Don't know where to start and get all the bricks you need?
Check out this video tutorial and be welcomed into the universe of custom creations!



<https://youtu.be/cMQKIU0-mwA>

Nouveau dans le monde des MOCs? Incertain ou commencer et obtenir toutes les pièces nécessaires?
Regardez cette vidéo tutoriel et soyez la bienvenue dans l'univers des créations sur mesure!

STEPS MILESTONES / ÉTAPES CLÉS

Base.....	1-41
Floor / Plancher	42-52
Cockpit Brace.....	53-83
Central Tower / Tour Centrale.....	84-98
Engine / Moteur.....	99-126
Airlocks / Sas.....	127-160
Tower Top / Haut de Tour.....	161-185
Left Mandible / Mandibule Gauche.....	186-226
Right Mandible / Mandibule Droite.....	227-265
Mid Reinforcements.....	266-284
Side Hull Walls / Murs.....	285-342
Furniture / Meubles.....	343-357
Underbelly / Ventre.....	358-366
Cockpit.....	367-414
Roof Plating / Toiture.....	415-467

MK-09

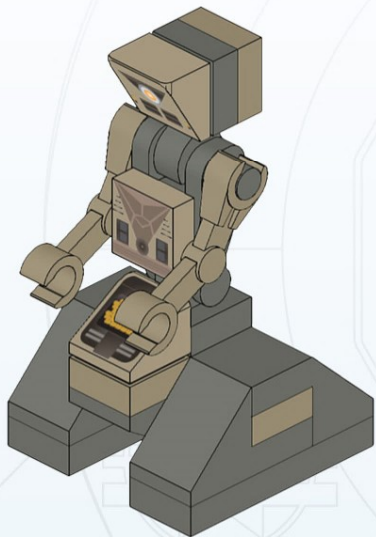

1

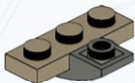
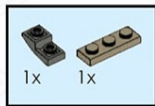

2

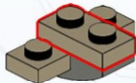

3

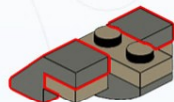

4

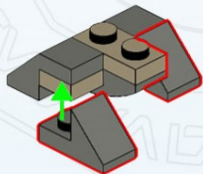

5

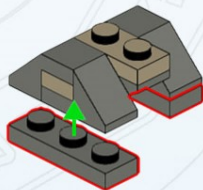
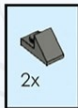

6

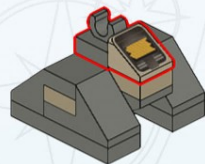
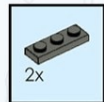

7

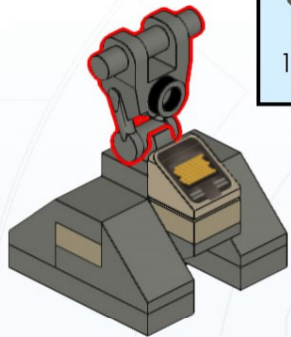

8

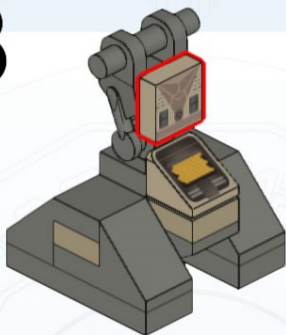

9

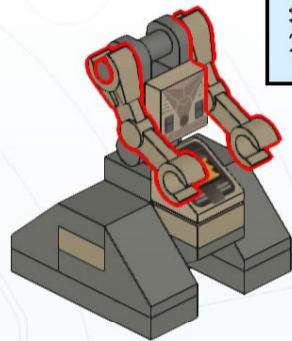

10

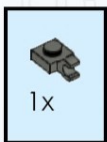
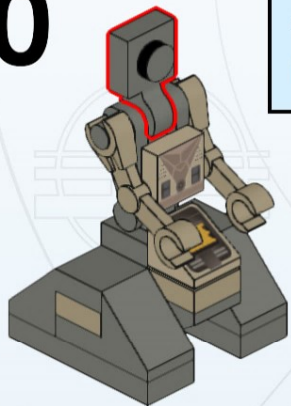

11

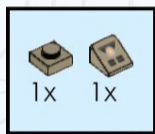
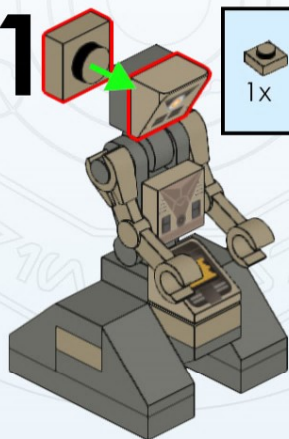

40

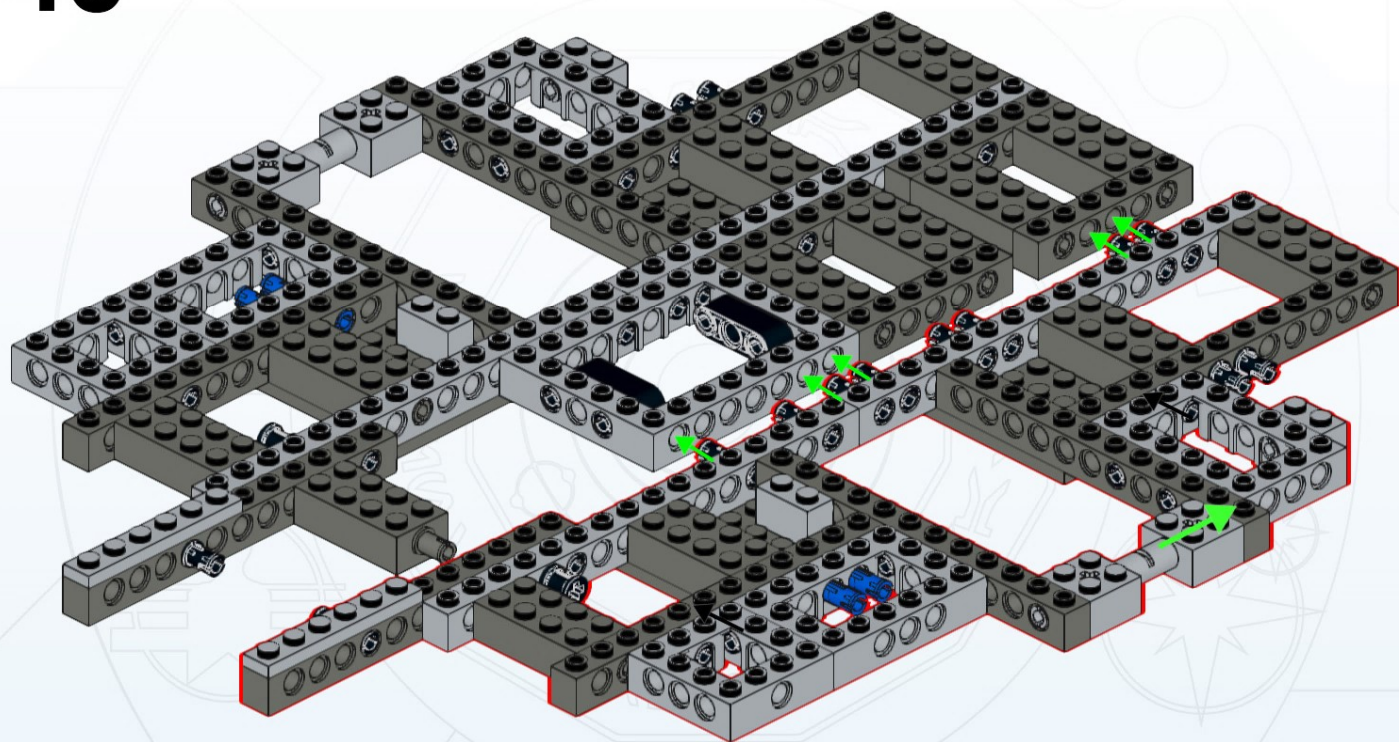

59

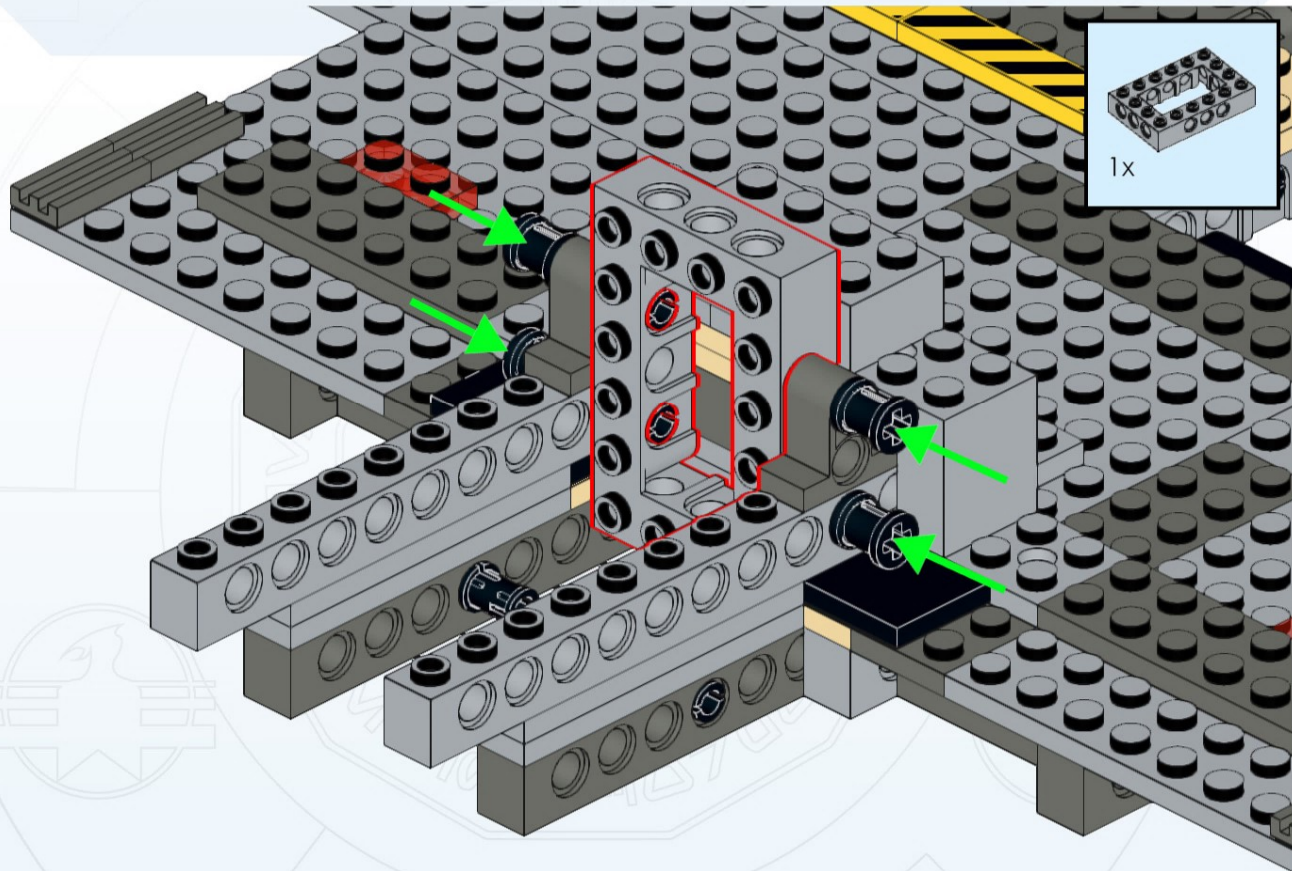

97

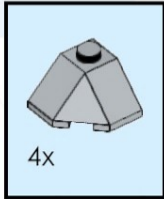
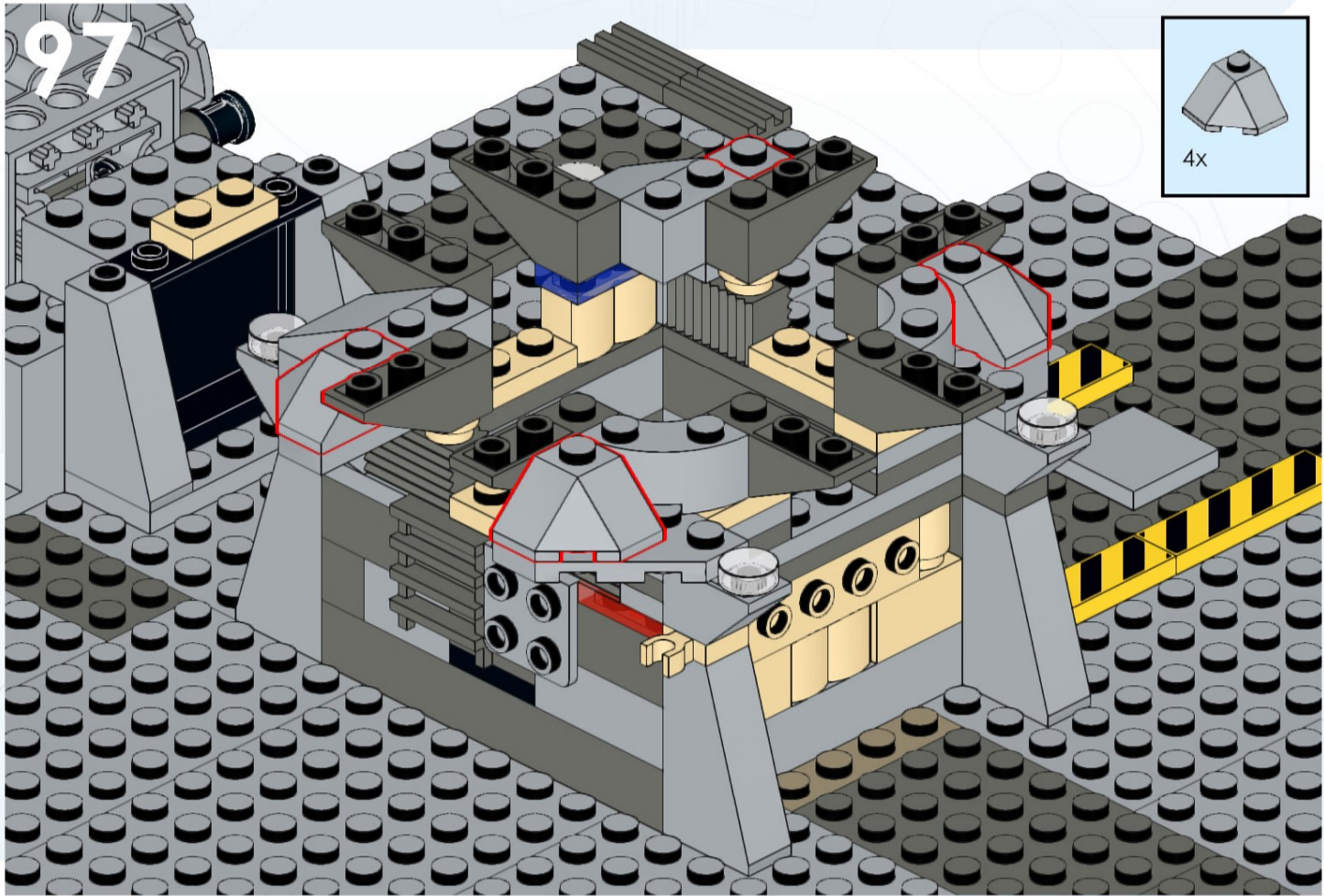

106

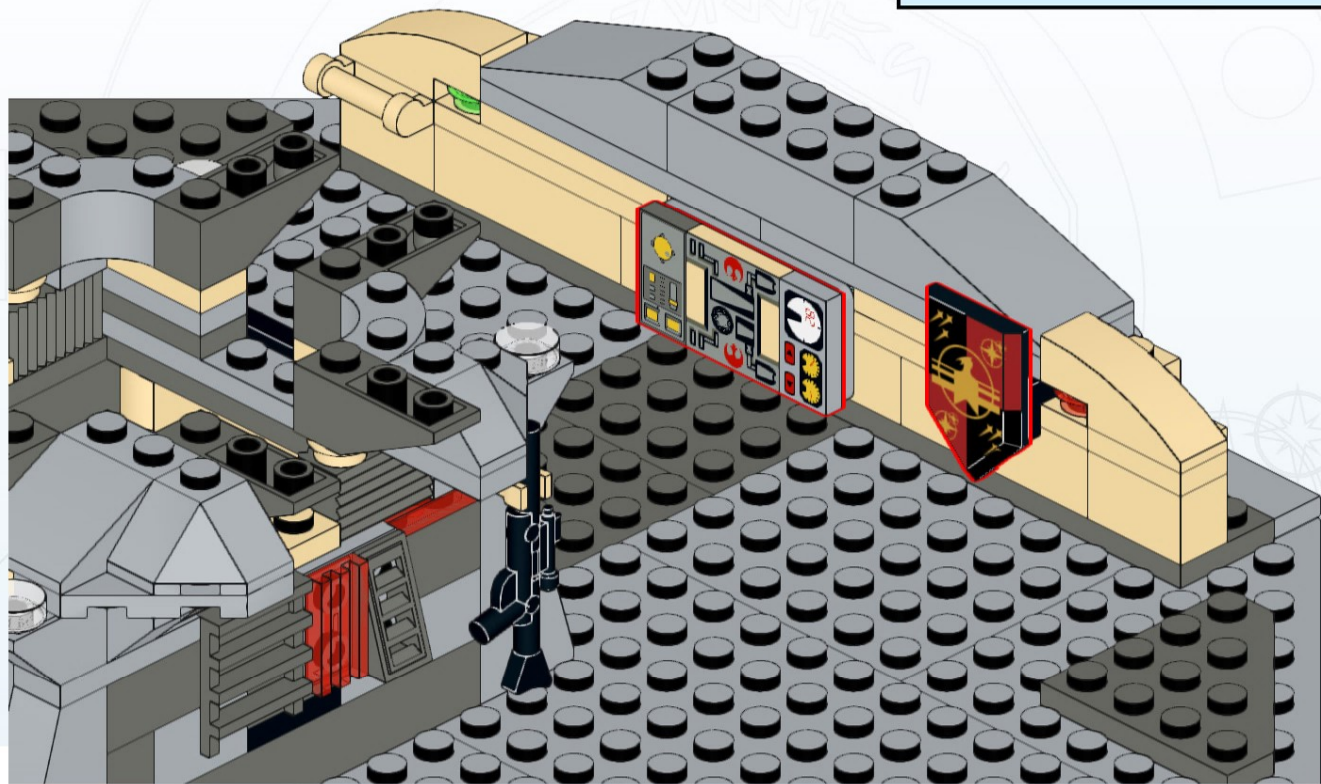
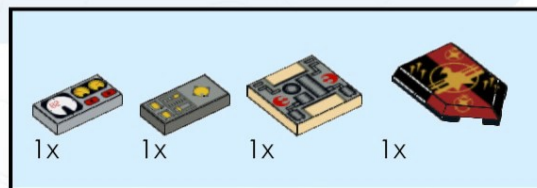

123

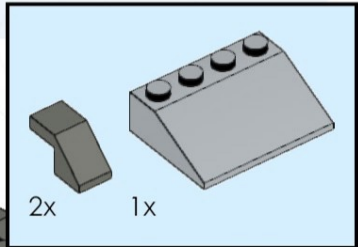
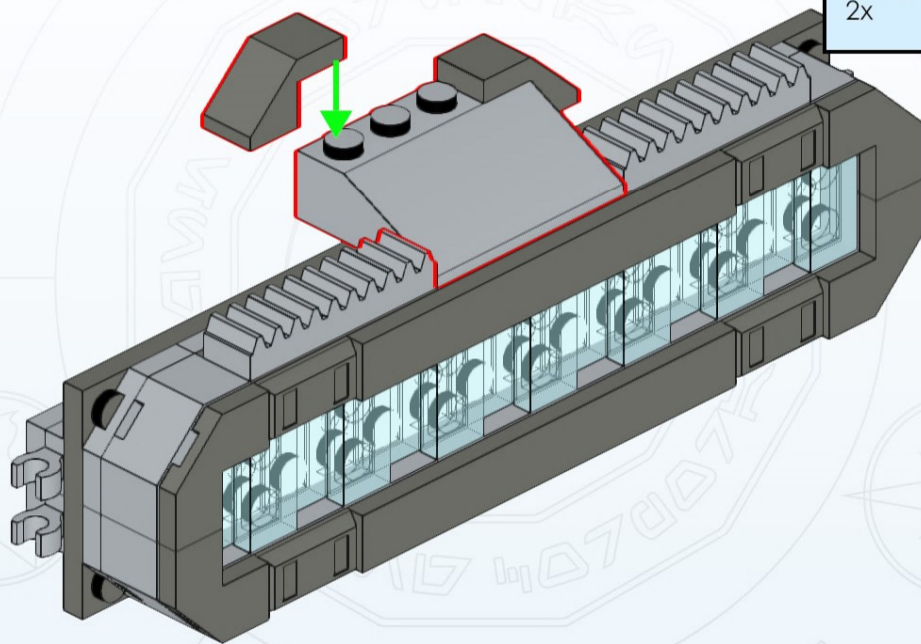

185

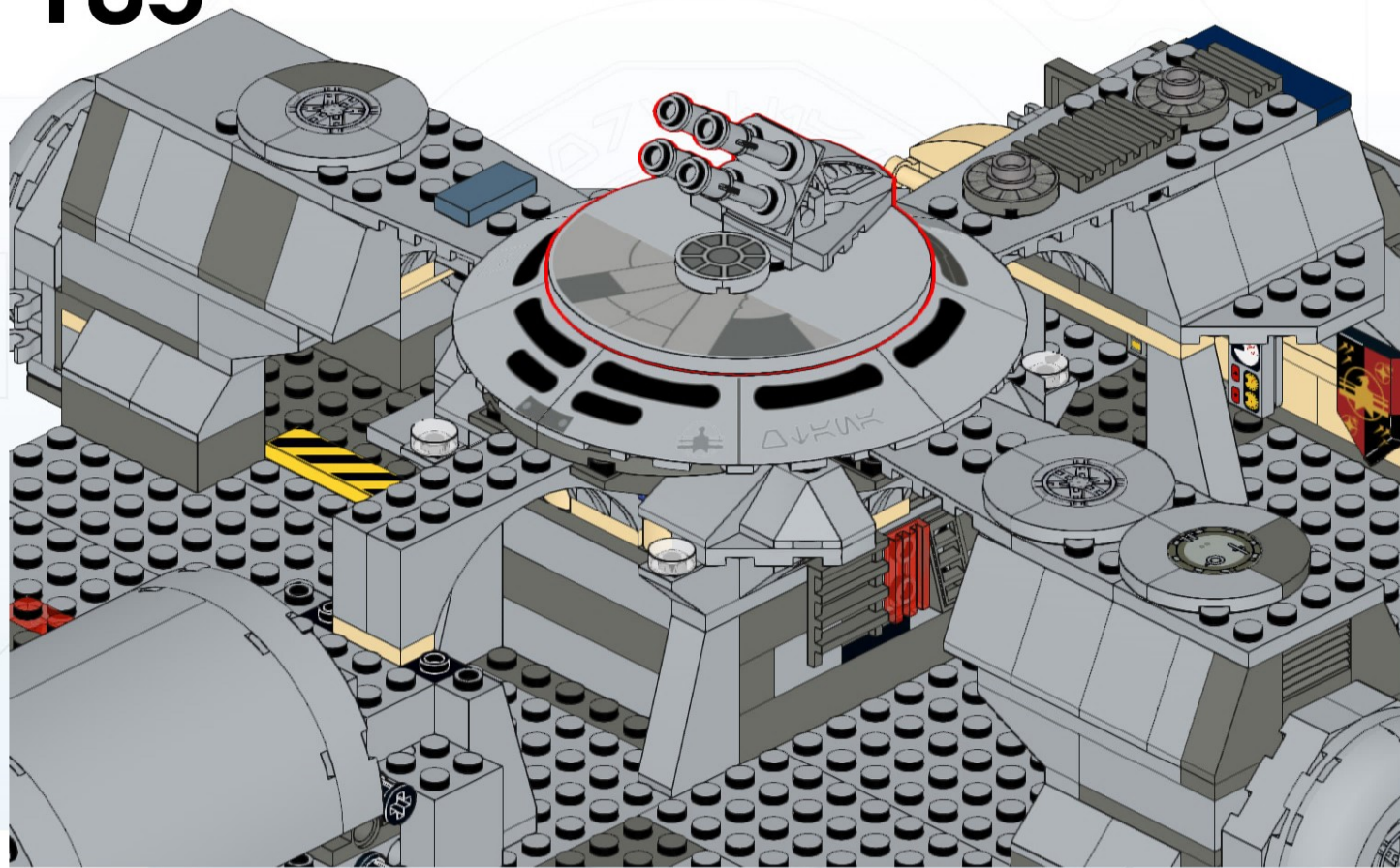

209

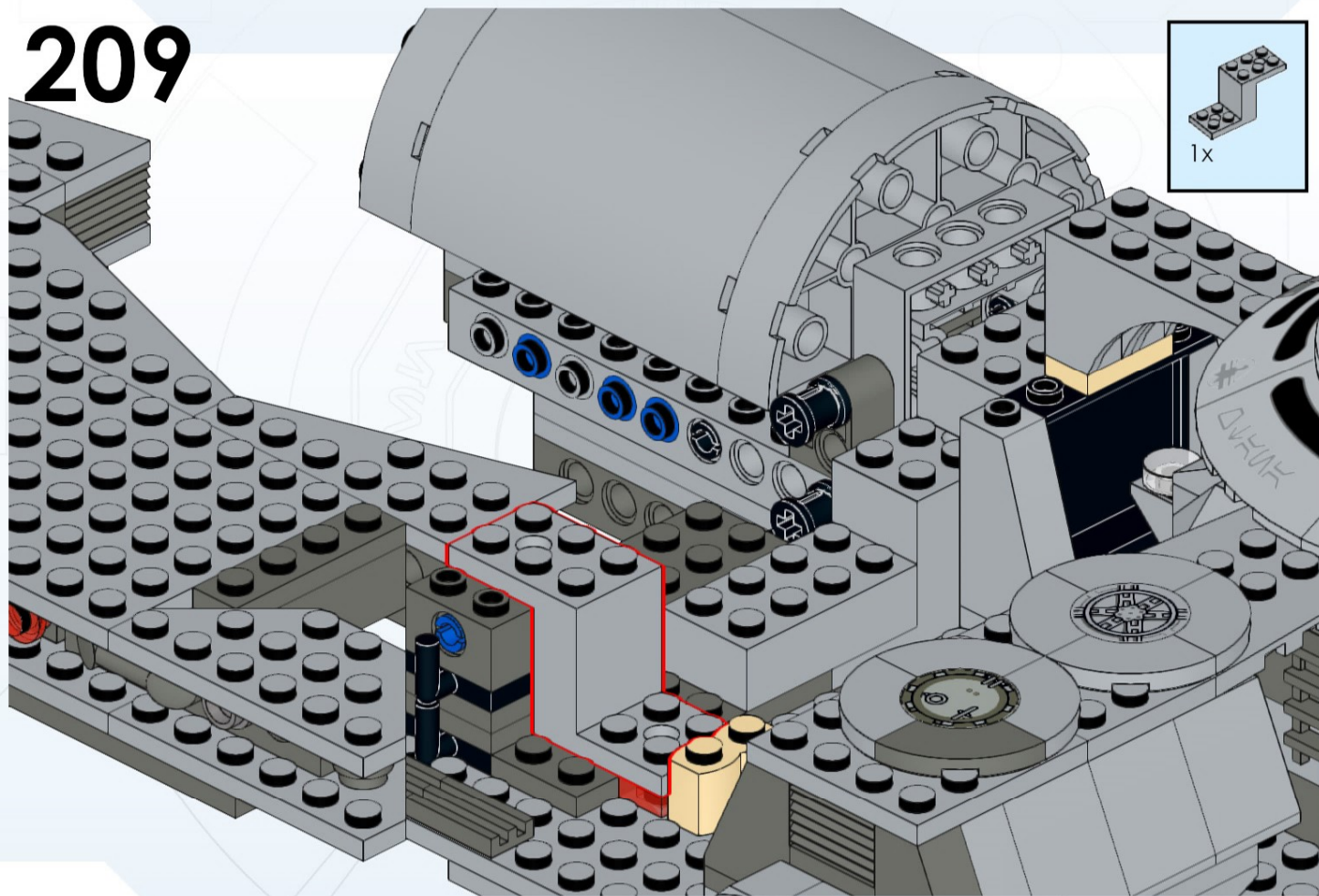

280

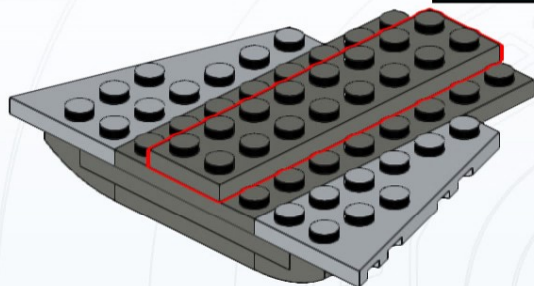
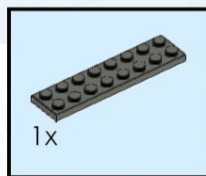

282

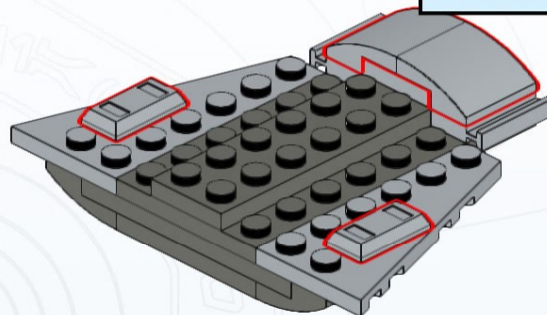
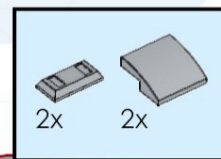

281

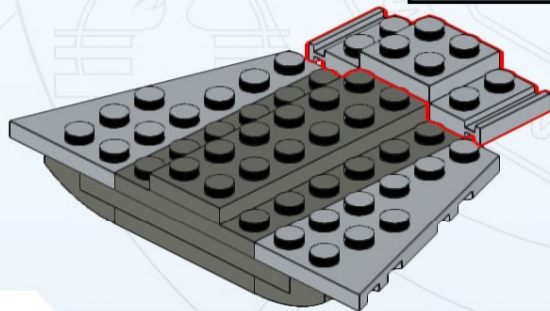
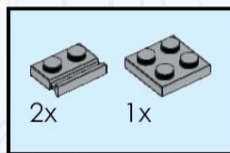

283

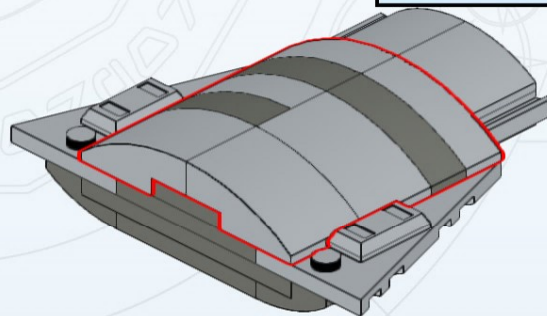
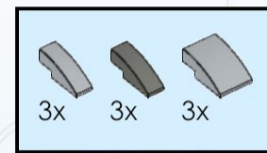

295

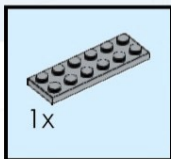
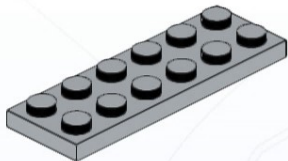
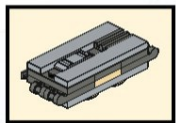

298

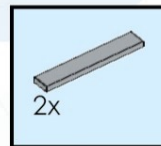
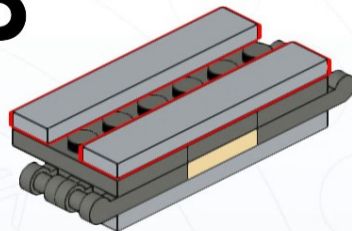

296

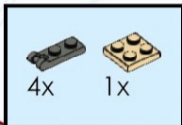
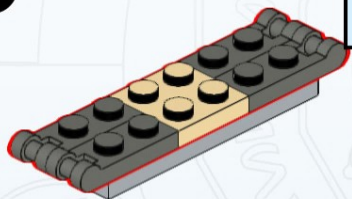

299

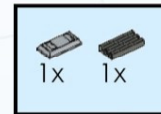
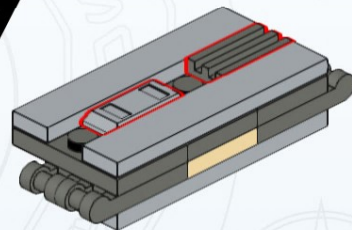

297

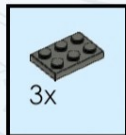
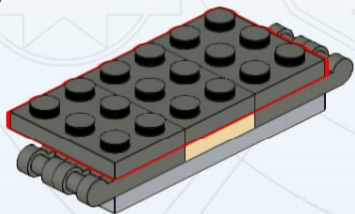

300

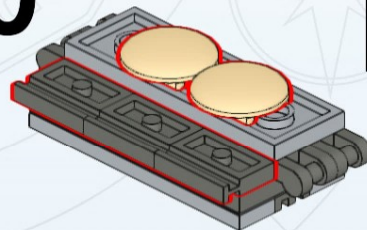

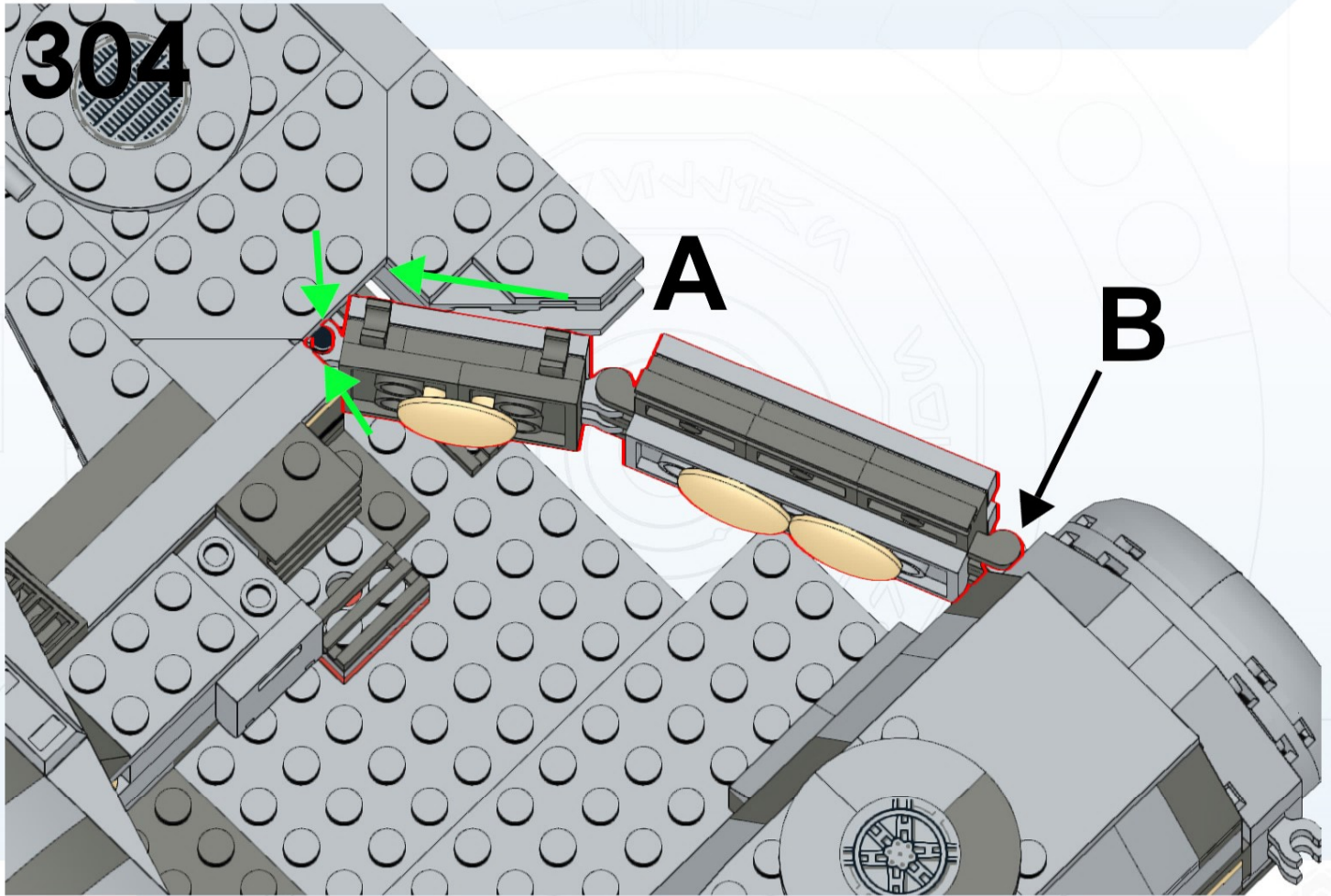

344

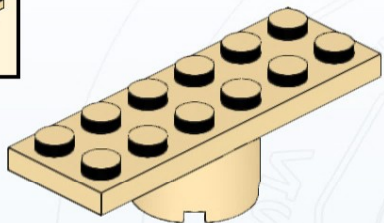
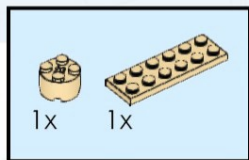

346

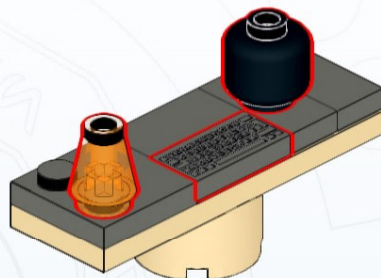
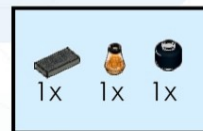

345

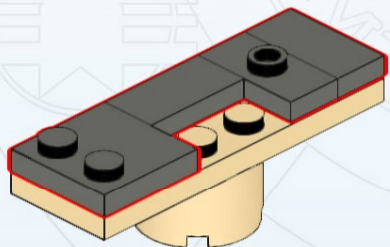
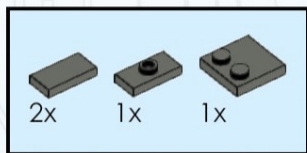

347



434

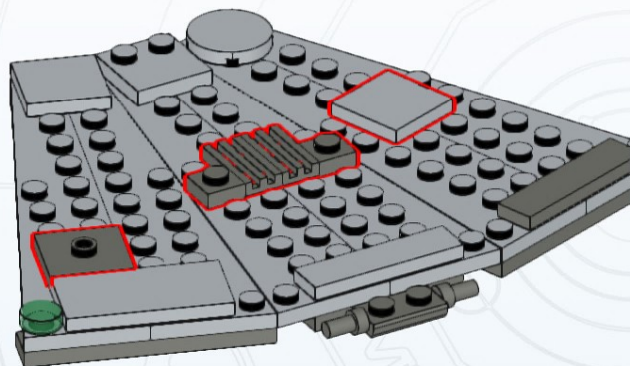
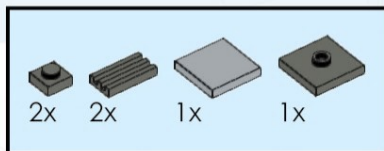

435

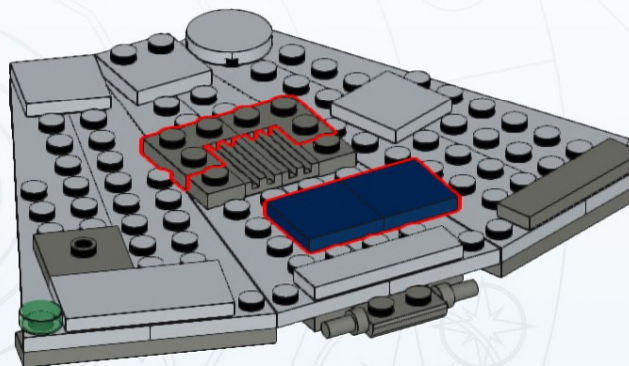
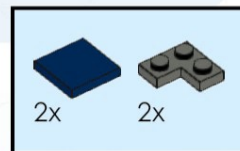

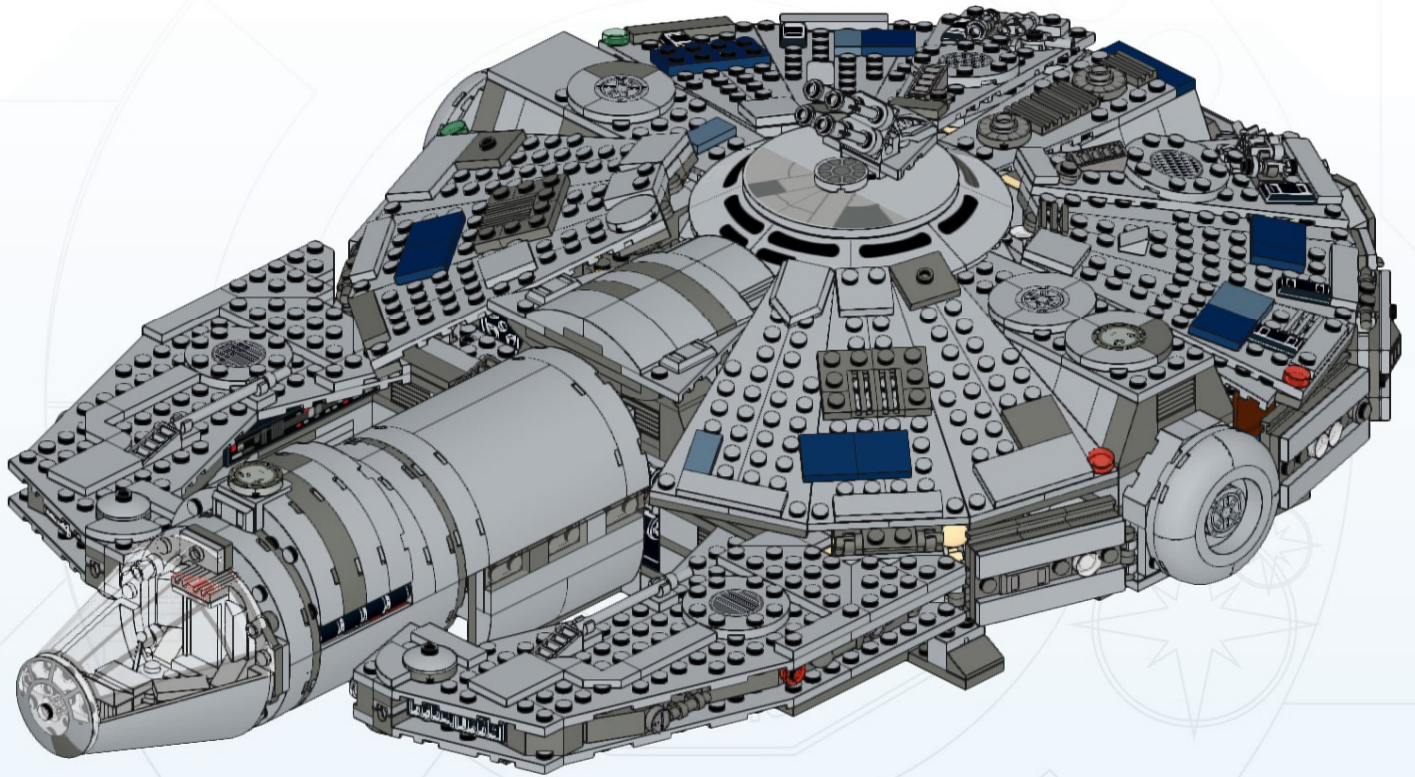

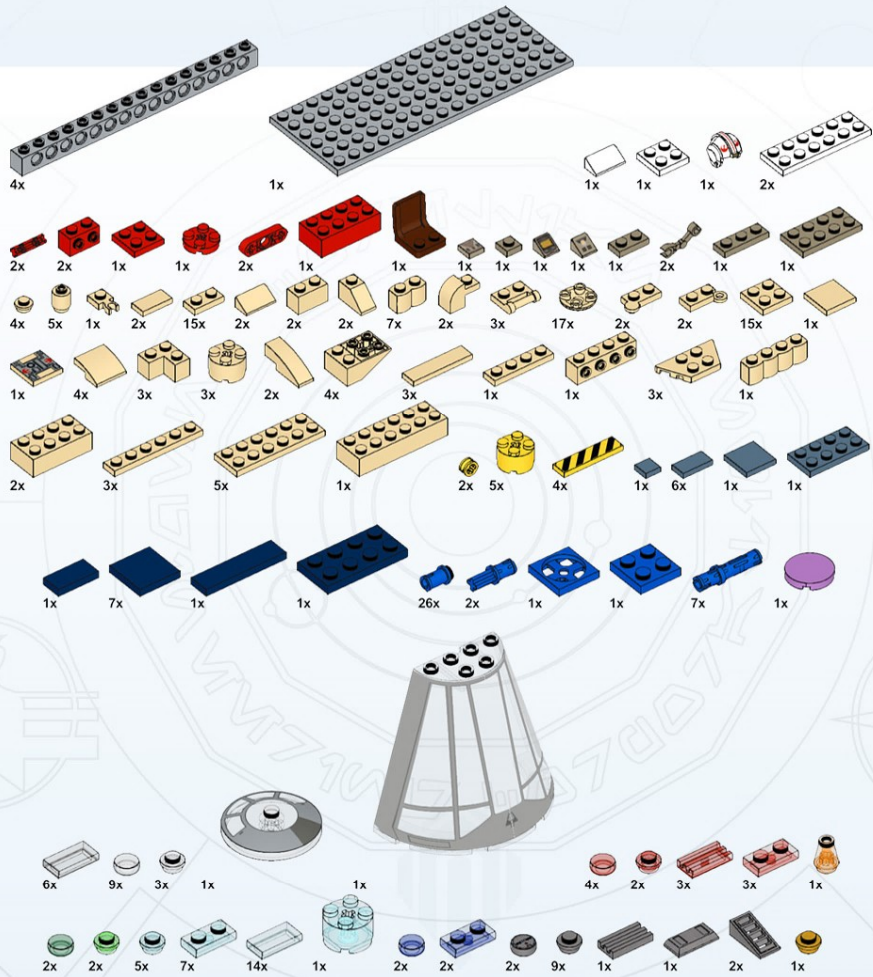

SPECIAL THANKS / REMERCIEMENTS



Pierre-Luc Bélanger
Eloi Parizeau
Gary Dessureault
Jenny Flansberry
Alex "Ironside" Potvin
Jimmy Desourdis
James Larocque
Daniel Couture
Annie Normandin



Marc-André Bazergui
Mimaki-Senpai



EpicJasonX9000



Jason Pyett
David Strenzler
Paul Lavallée
Carlos Serratos
CJ Hendrix
Nathanaël Kuipers



Stach Bricks
Canada First Bricks
Onebrick@atime
Zone Brix
Life in Plastic
Dan the Brick Man
Leopard37
GTABricks



Friends & Family
Stacy Boisvert
Maxime Dero
Maxime Chapdelaine
Maxime Cuerrier
Marc-André Grenier
Jean-Philippe Borduas
Mathieu Gendron Denis
Jonathan Labrie
Simon Charron
Nicolas Sigounis
Roxanne Ross
Marc Bobby Wong
Marie-Pier Contant
Catherine Thériault
William Fafard
Cat Merlini
Stefanny Fodor
Roch Magnan
Sarah Dagar



Sanji

