

# firefly

MOC-107154

FIREFLY CLASS TRANSPORT

## SERENITY

959

pcs/pzs

\*EXCLUDING MINIFIGS

**PREVIEW**



DESIGNED BY



APOCRYPHEA

Playwell Bricks

# PREFACE

My Name is Jonathan, and I am a French-Canadian AFOL with a love for Science Fiction, and more specifically, ships!

I now hold a career in the video game industry as a Game & Level Designer.

Firefly is one of my most defining and favorite TV series of all time. There is no other cast ensemble that I love as much as this crew, and their adventures in the frontiers of space.

There are very few Firefly collectibles out there, and I figured maybe a LEGO build would scratch that itch - However, there wasn't much I could find in terms of reasonable and suitable size and scope... Until I found Slick\_B175's model.

Over the course of a few months I gathered all that was needed to build it, and even though the original model was great to start with, I felt I could bring substantial improvements and major overhauls, so I got in touch with Slick and got greenlit for a newer, improved version!

This was also the perfect opportunity to practice my decal making skills, as well as minifigure design. I wanted to create the full crew as LEGO minifigures, as well as highlight many details from the ship through the use of stickers/prints.

I also re-designed this project with the same criteria you'd expect from a real product. Quality, Accuracy, Solidity, Stability, Techniques and Optimization.

I hope you enjoy this build as much as I did undertaking its completion!



Mon nom est Jonathan et je suis un canadien français, Fan de Lego Adulte avec un amour pour la Science Fiction et, plus spécifiquement, des vaisseaux!

Je détiens maintenant une carrière dans l'industrie du jeu vidéo en tant que Concepteur de Jeux & Niveaux.

Firefly est une de mes séries de TV préférées et marquantes de tous les temps. Il n'y a aucune autre émission qui présente un ensemble d'acteurs aussi adoré et synergique, ainsi que leurs aventures dans les frontières de l'espace.

Il y a très peu de produits de Firefly existants et, je me suis dit qu'une conception LEGO serait peut-être la solution à cet embêtement. Toutefois, il n'y avait pas beaucoup de constructions que j'estimais raisonnables et appropriées en termes de grosseur et coût...jusqu'à ce que je découvre le modèle de Slick\_B175.

Au fil des mois, j'accumule les pièces nécessaires pour le construire, et même si le modèle original était un bon départ, je sentais que je pouvais y apporter des améliorations substantielles et des révisions majeures. J'ai donc contacté l'auteur original et reçu son feu vert pour concevoir cette nouvelle version améliorée!

Ceci était l'opportunité parfaite pour moi de mettre au travail mes talents de « decals », ainsi que la conception de minifigurines. Je voulais créer l'équipage complet en minifigurines, ainsi que souligner les fins détails du vaisseau avec des autocollants/prints.

J'ai retravaillé ce projet dans la même optique ainsi que les mêmes critères que vous pouvez vous attendre d'un vrai produit LEGO: Qualité, Fidélité, Solidité, Techniques et Optimisation.

J'espère que vous aimerez cette construction autant que j'ai eu de plaisir à la réaliser!



## Cheers! Au Plaisir!

Jonathan D.M  
// APOCRYPHEA



# ORIGINS

*Firefly* is an American space Western drama television series, created by writer and director *Joss Whedon* - The show blends elements from the space opera and Western genres, depicting humanity's future in a manner different from most contemporary science fiction programs. *Firefly* takes place in a multi-social/cultural future, primarily a fusion of Western and East Asian societies, where there is gross class inequality. Following a civil war, the crew of a small transport spaceship make a living on the fringes of society. An ensemble cast defined the nine crew members and passengers of the ship, named *Serenity* - which is itself a *Firefly Class* vessel.

Unfortunately, the show suffered an ill-conceived airing plan and was therefore doomed to a premature cancellation. With episodes aired in incorrect order, on a graveyard timeslot, *Serenity* only had a very small following when it was live. The success and love for this show actually came post-mortem once it was released on DVD - People discovered it was such a hidden gem, it kept gaining a massive following to the point where a movie was made to wrap things up later, to the demand of the ever growing fan-base.

Despite its short life... Many things make *Firefly* beyond special and beloved. The depth and uniqueness of the worldbuilding, the complexity of the characters and the incredible chemistry between them, the poignant narratives - all make for a complete experience that left little loose ends, and a richness that many shows struggle to achieve even over multiple seasons.

One thing is for sure, anyone who has watched this show will forever remember it and keep it close to heart, as I do!

# ORIGINES

*Firefly* est une série américaine de drame et de science-fiction de style western, conçue par le Directeur *Joss Whedon*. L'émission mélange plusieurs éléments des genres Western et d'opéra spatial, illustrant le futur de l'humanité très différemment des sciences-fictions contemporaines. *Firefly* se déroule dans un futur multi-social/culturel, dans une fusion des sociétés de l'ouest et de l'Orient, où se vit une grande inégalité des classes sociales. Suite à une guerre civile, l'équipage d'un petit vaisseau de transport vit aux frontières de la société. La bande de 9 acteurs constitue les membres d'équipage et passagers du vaisseau, dénommé le *Serenity*, lui-même étant un vaisseau de classe *Firefly*.

Malheureusement, l'émission souffrait d'une mauvaise planification de diffusion, ce qui le condamne à une annulation prématurée. Les épisodes furent diffusés dans le mauvais ordre et dans une plage horaire d'oubliettes - Très peu de gens connaissent la série au moment où elle existait en temps réel. Toutefois, le succès et l'amour pour cette émission vient post-mortem, lorsqu'elle sortait sur DVD. Les gens ont rapidement découvert qu'il s'agissait d'un joyau caché, au point tel que sa popularité explosive a permis de réaliser un film pour satisfaire la (fan base) grandissante et de conclure proprement l'histoire.

Malgré sa courte durée de vie, plusieurs éléments font de *Firefly* quelque chose d'uniquement spécial et bien-aimé. La profondeur de la diégétique, la complexité des personnages et la chimie incroyable entre ceux-ci et le narratif poignant sont tous des facteurs contribuant à une expérience complète et enrichissante que peu d'émissions arrivent à rivaliser même au travers de plusieurs saisons.

Une chose est certaine, n'importe qui ayant écouté cette émission s'en souviendra pour toujours et la garde proche du cœur, comme moi-même!





# SPECIFICATIONS

The Firefly-class transport ship is a series of Multipurpose, Mid-Bulk Transport boats designed by Allied Spacecraft Corporation. All Fireflies feature a large rear engine module, wing-mounted engines capable of vertical takeoff and landing (VTOL), a centralized cargo section, and raised forward section holding the crew quarters and bridge. When the engines activate, they glow up, inspiring the eponymous name of the ship class.

Le vaisseau transport de classe Firefly est une série de cargo multi-usage conçu par la "Allied Spacecraft Corporation". Tous les Firefly ont la caractéristique d'un module d'engin arrière assez large, ainsi qu'une capacité de décollage verticale (VTOL), une section de cargaison centrale, une fuselage avant surélevé contenant les quartiers d'équipages et le pont. Lorsque les engins s'activent, ils créent une forte lueur, inspirant ainsi le nom de classe du vaisseau.

Manufacturer:  
Allied Spacecraft Corporation  
Length: 82 Meters

Accel: 5.5G  
Range: 750 A.U.

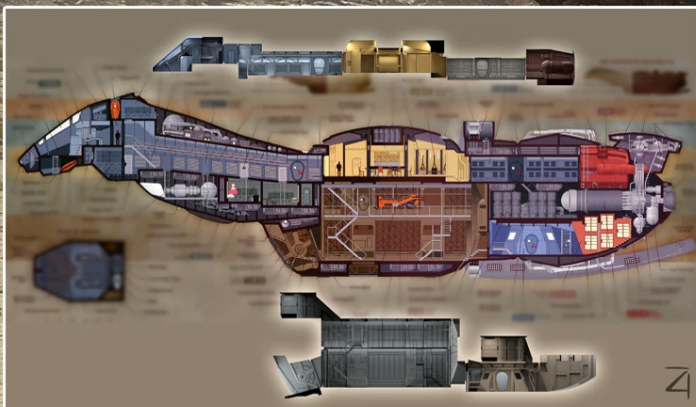
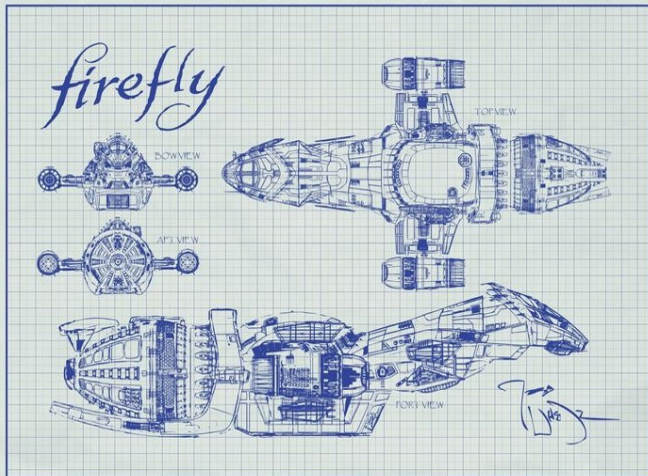

MALCOLM REYNOLDS



JAYNE COBB



SHEPHERD BOOK



ZOE WASHBURNE



INARA SERRA



SIMON TAM

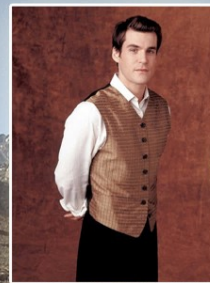

HOBAN WASHBURNE



KAYLEE FRYE

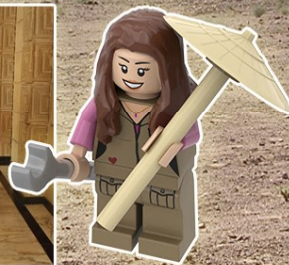

RIVER TAM



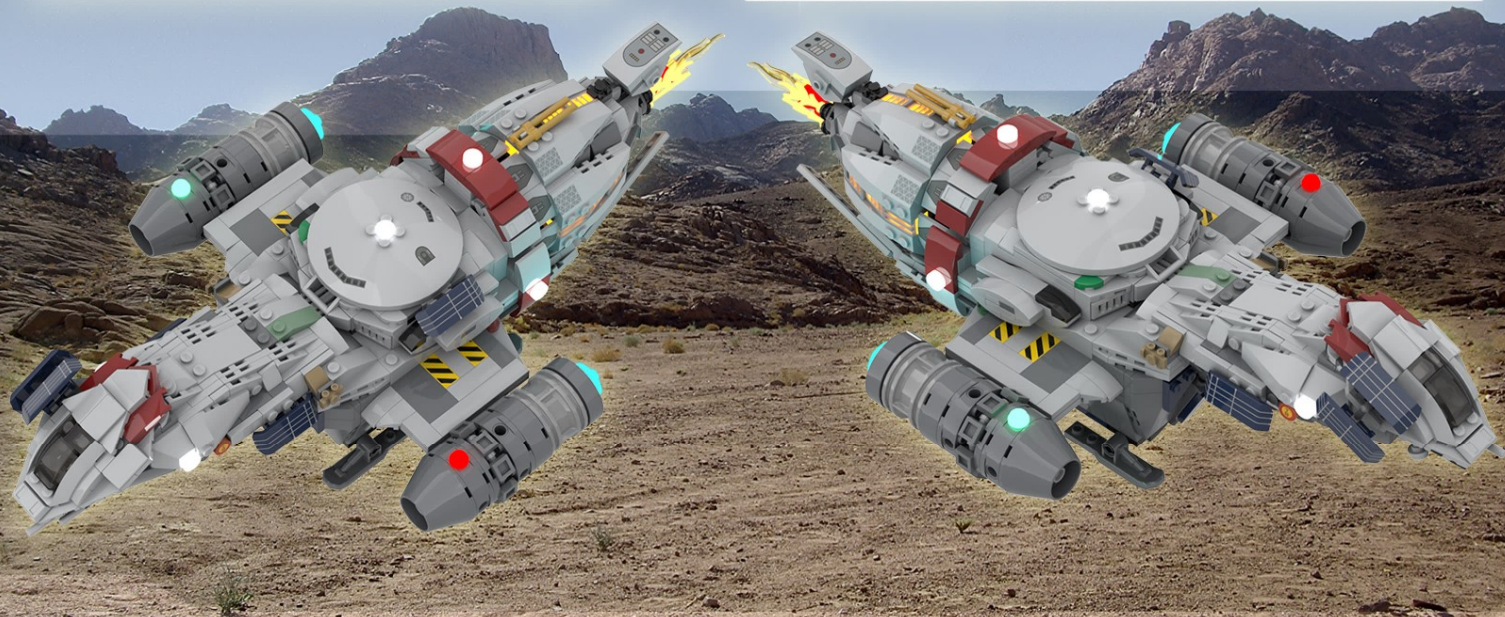
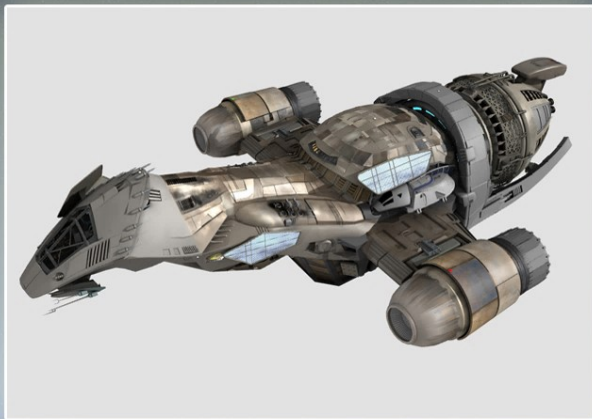

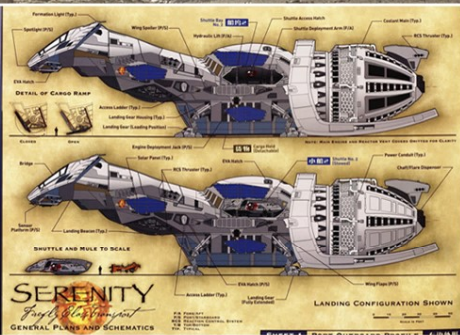
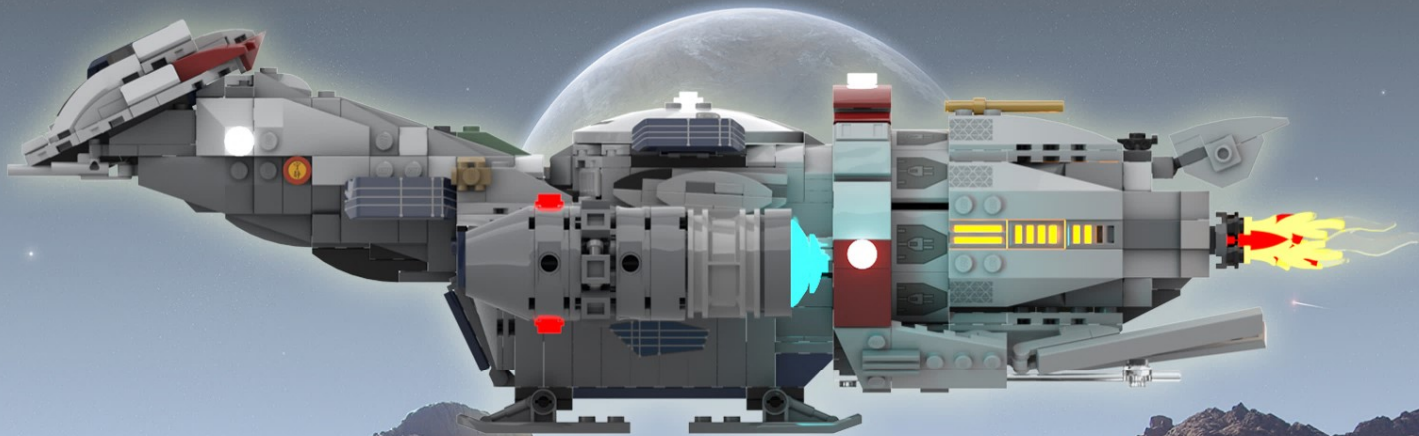





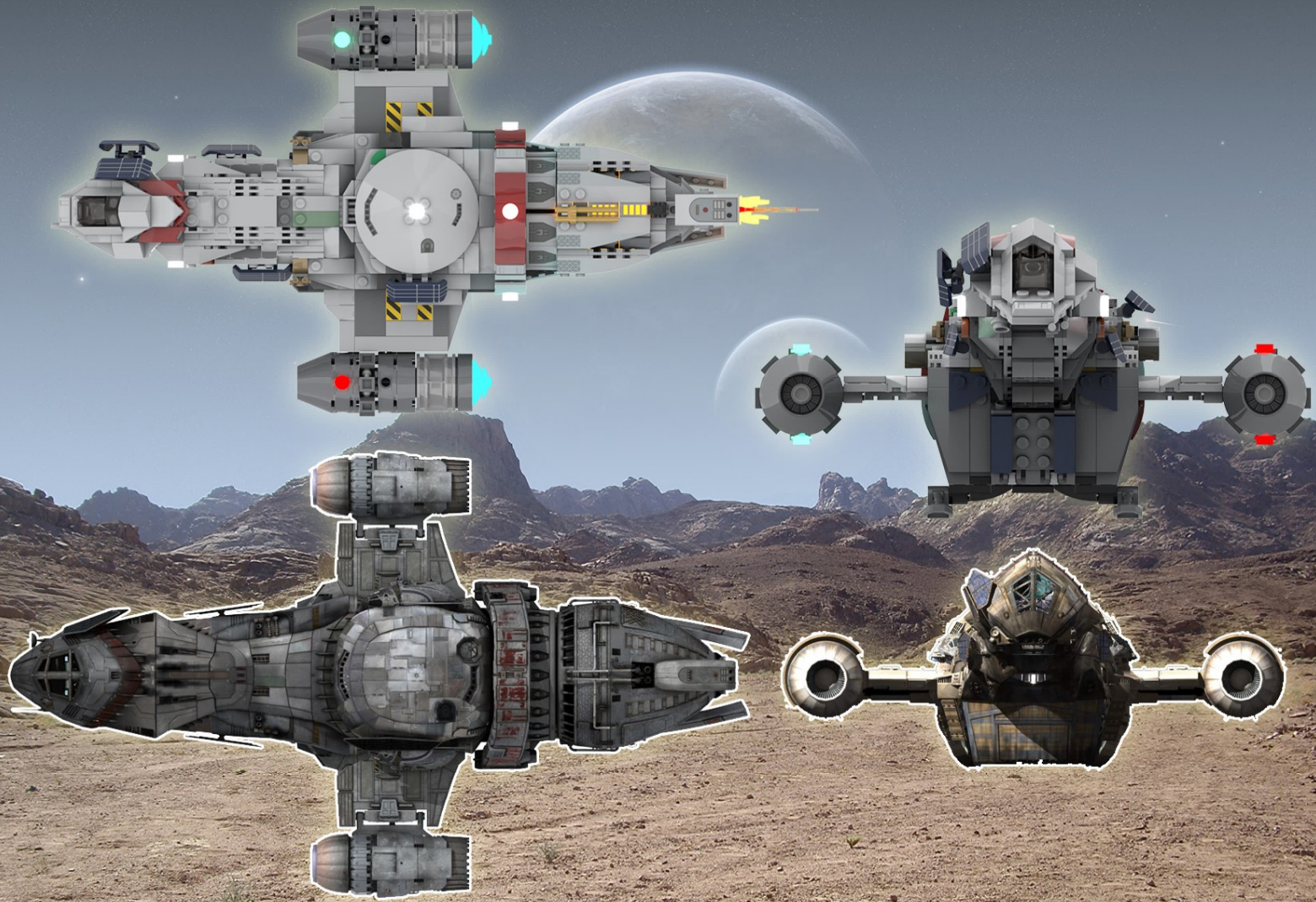





New to the world of MOCs? Don't know where to start and get all the bricks you need? Check out this video tutorial and be welcomed into the universe of custom creations!

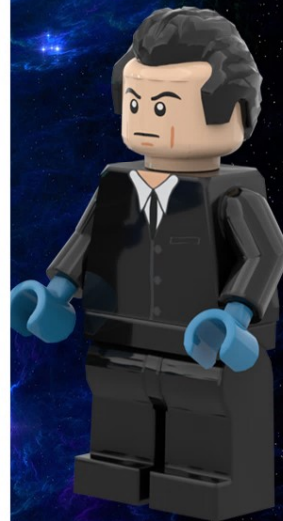

<https://youtu.be/cMQKIU0-mwA>

Nouveau dans le monde des MOCs? Incertain ou commencer et obtenir toutes les pièces nécessaires? Regardez cette vidéo tutoriel et soyez la bienvenue dans l'univers des créations sur mesure!

16

不能把天空从我身边带走

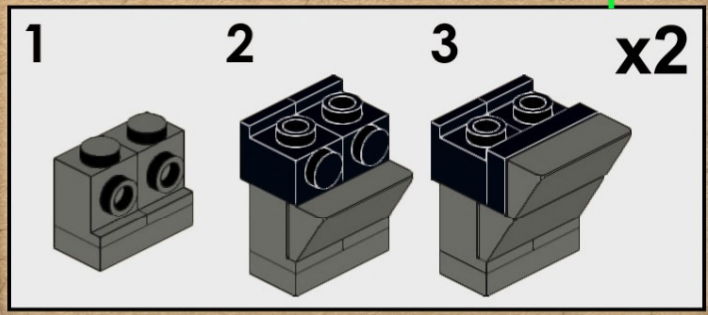
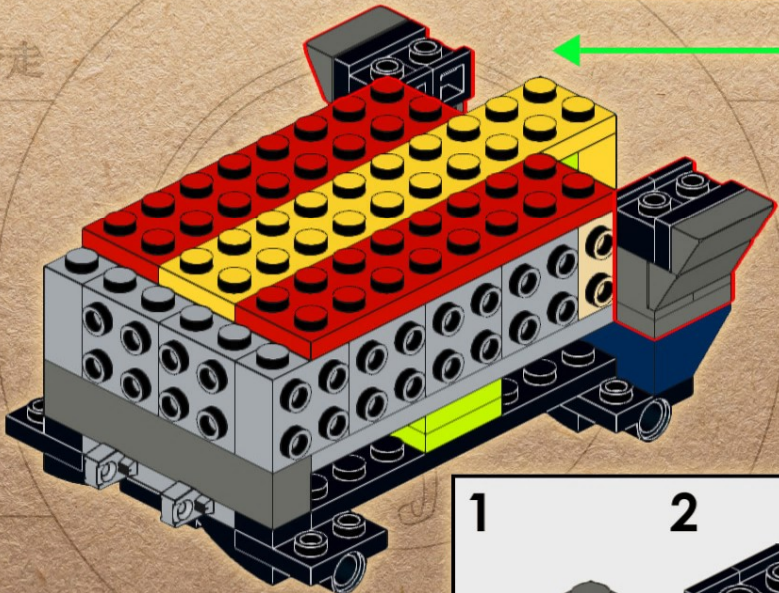
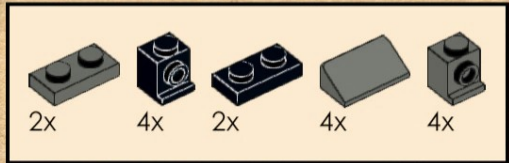

53

不能把天

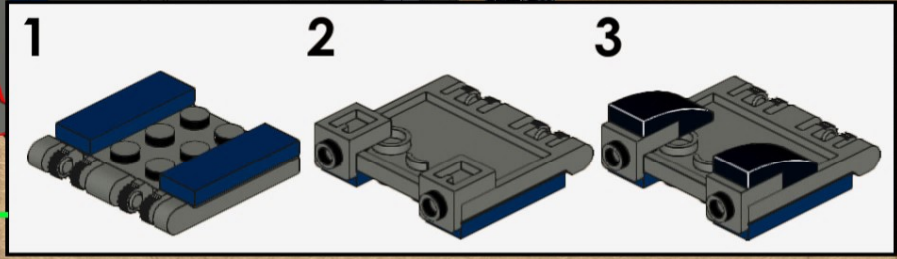
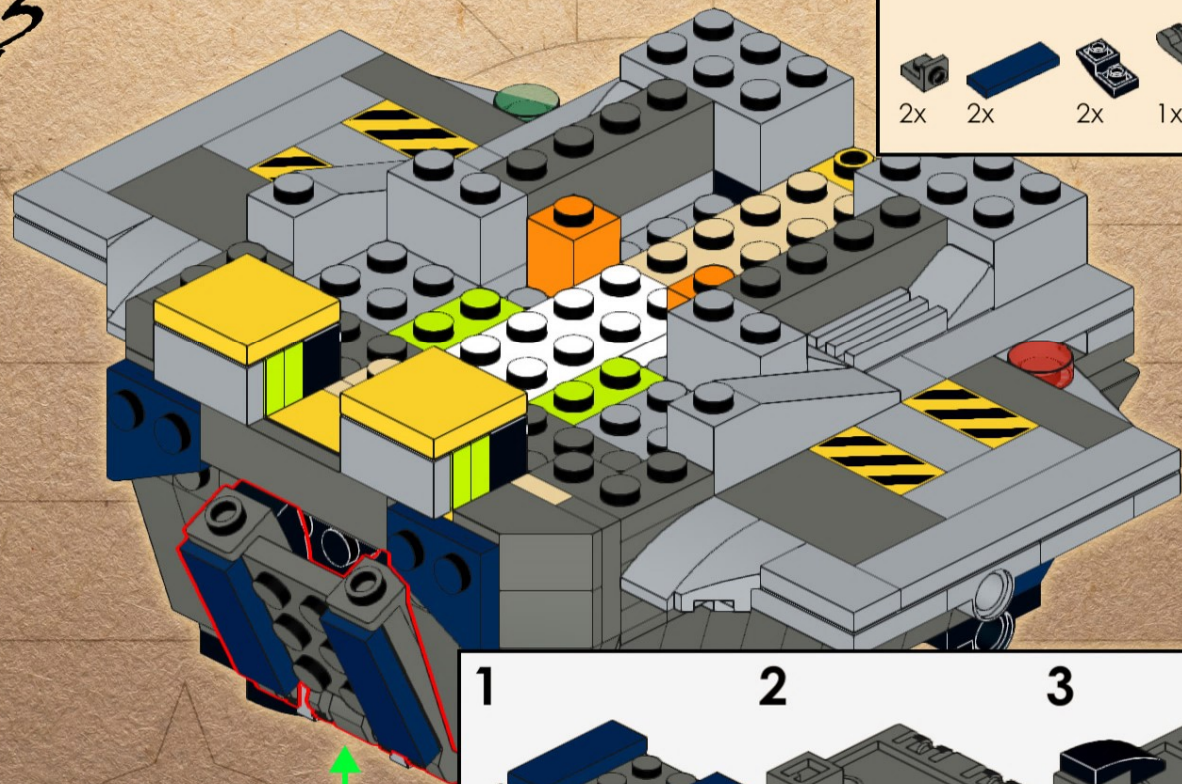
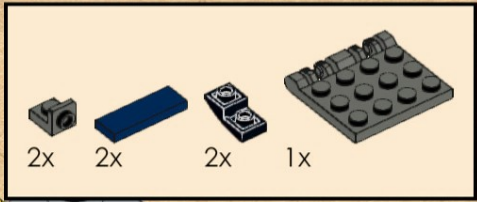

56

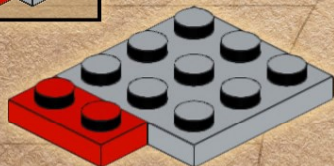
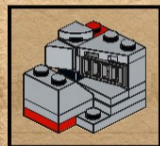
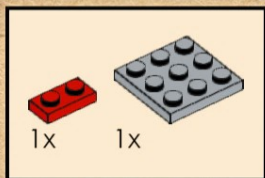

57

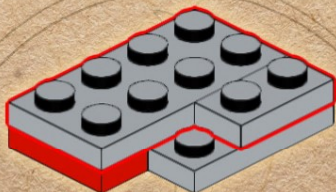
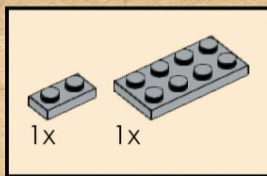

58

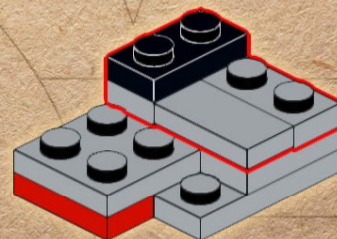
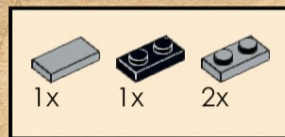

59

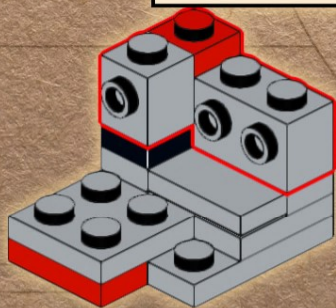
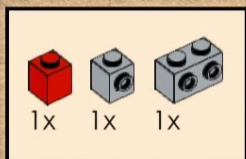

60

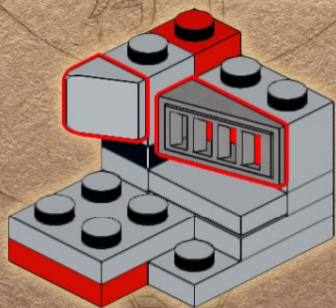
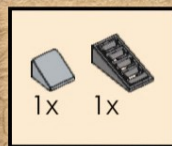

61

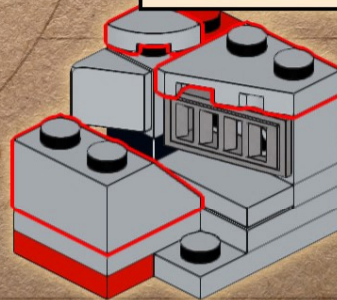
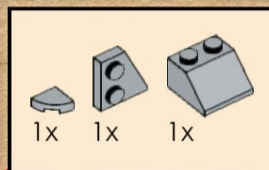

110



身边带走

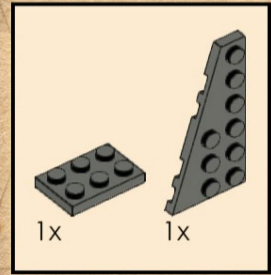

111

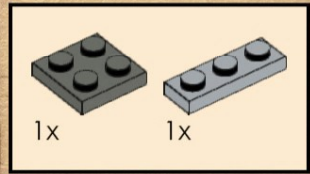
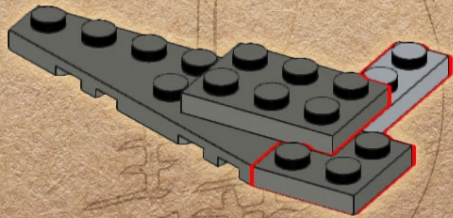

112

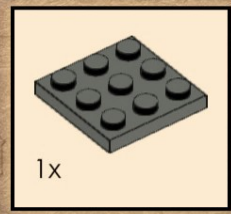
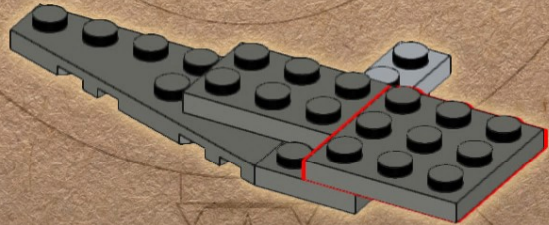



161

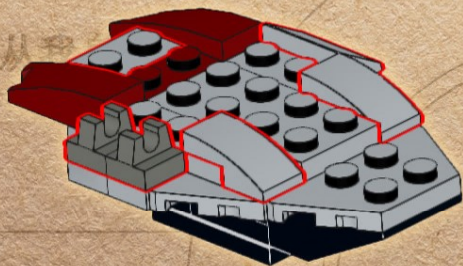
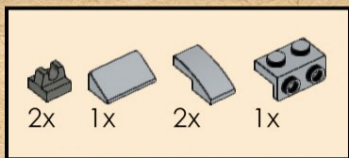

162

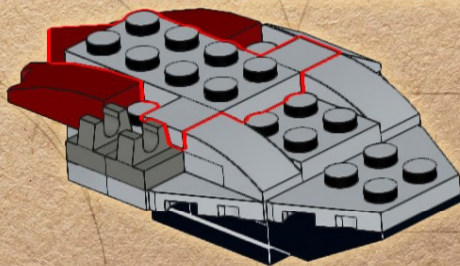
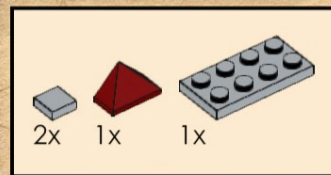

163

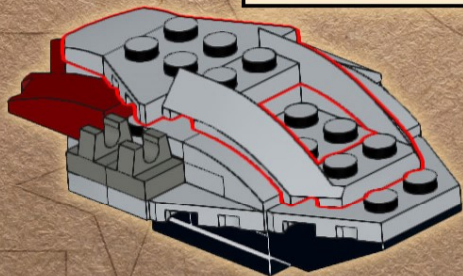
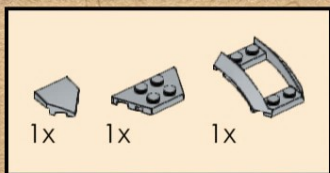

164

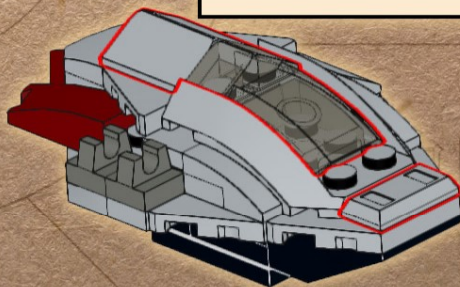
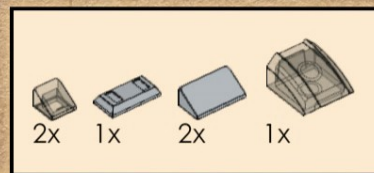

167

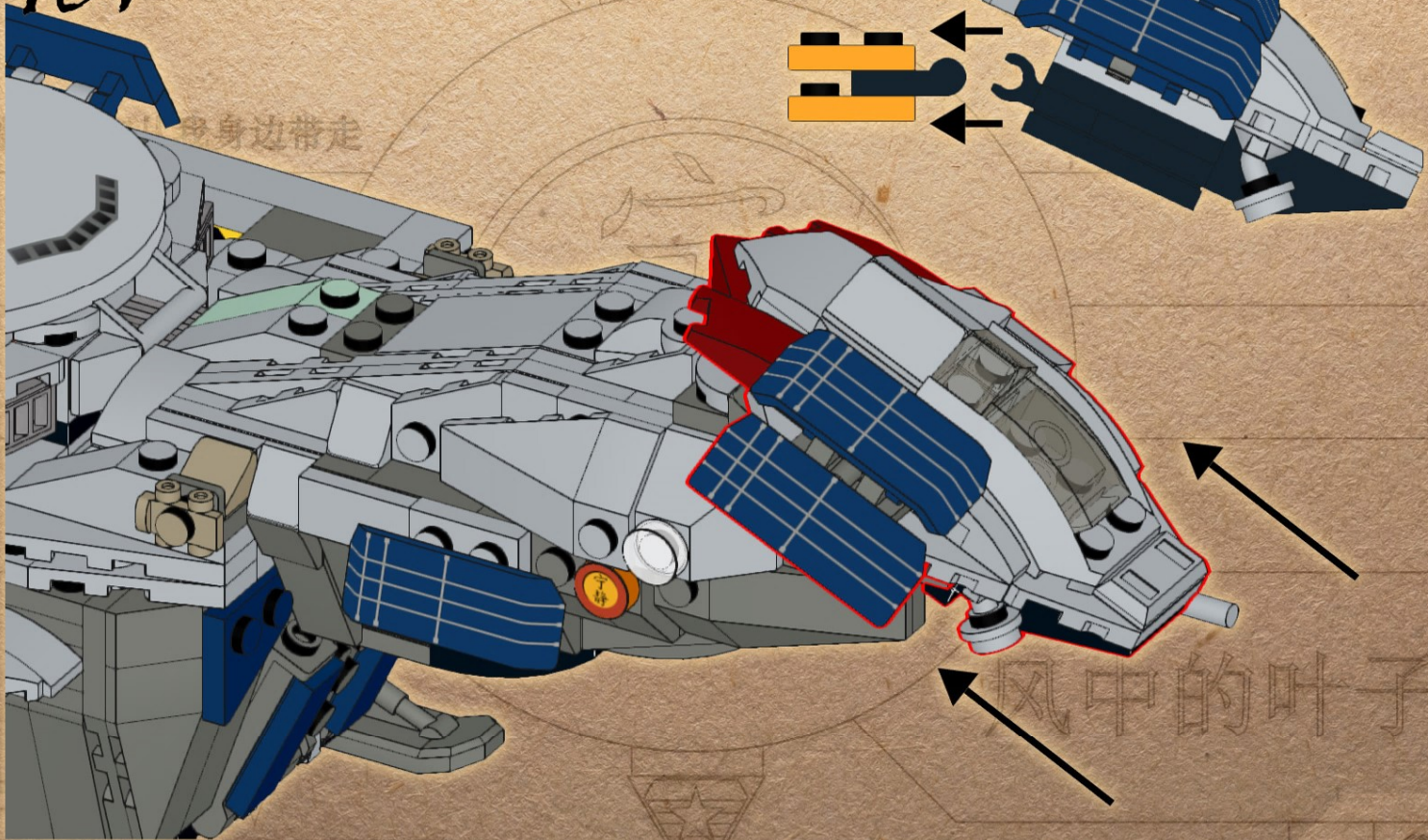

194

不能把天空从我身边带走

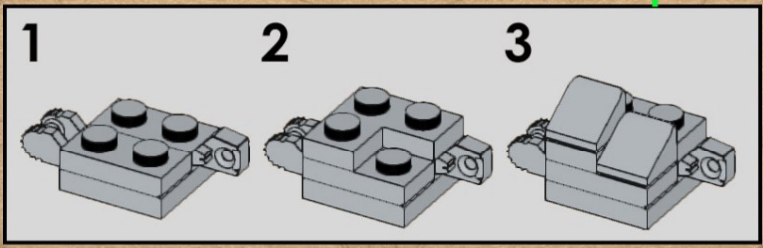
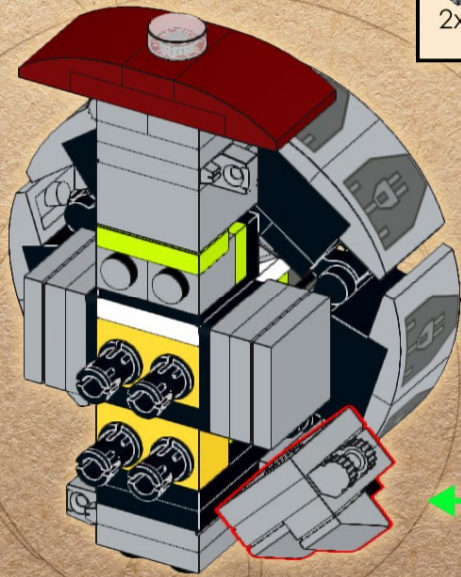
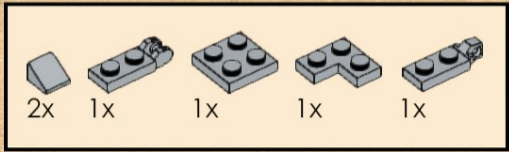

中的叶子



310

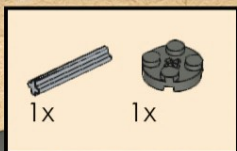
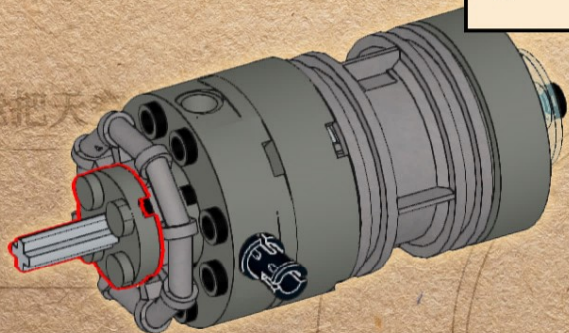

312

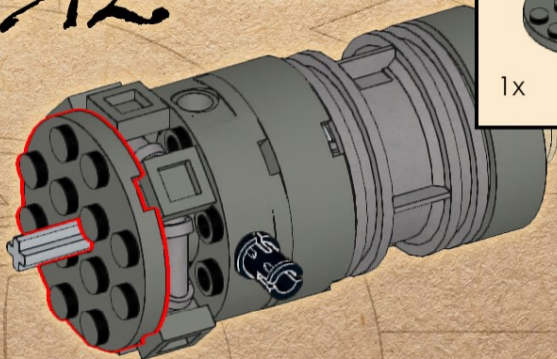

311

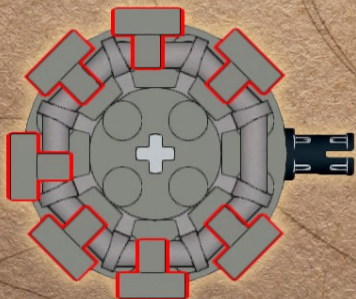

313

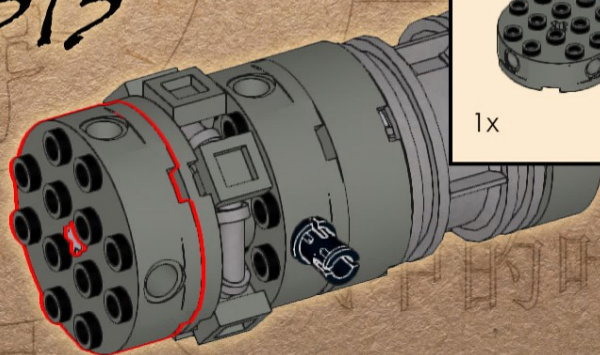

不能把天空

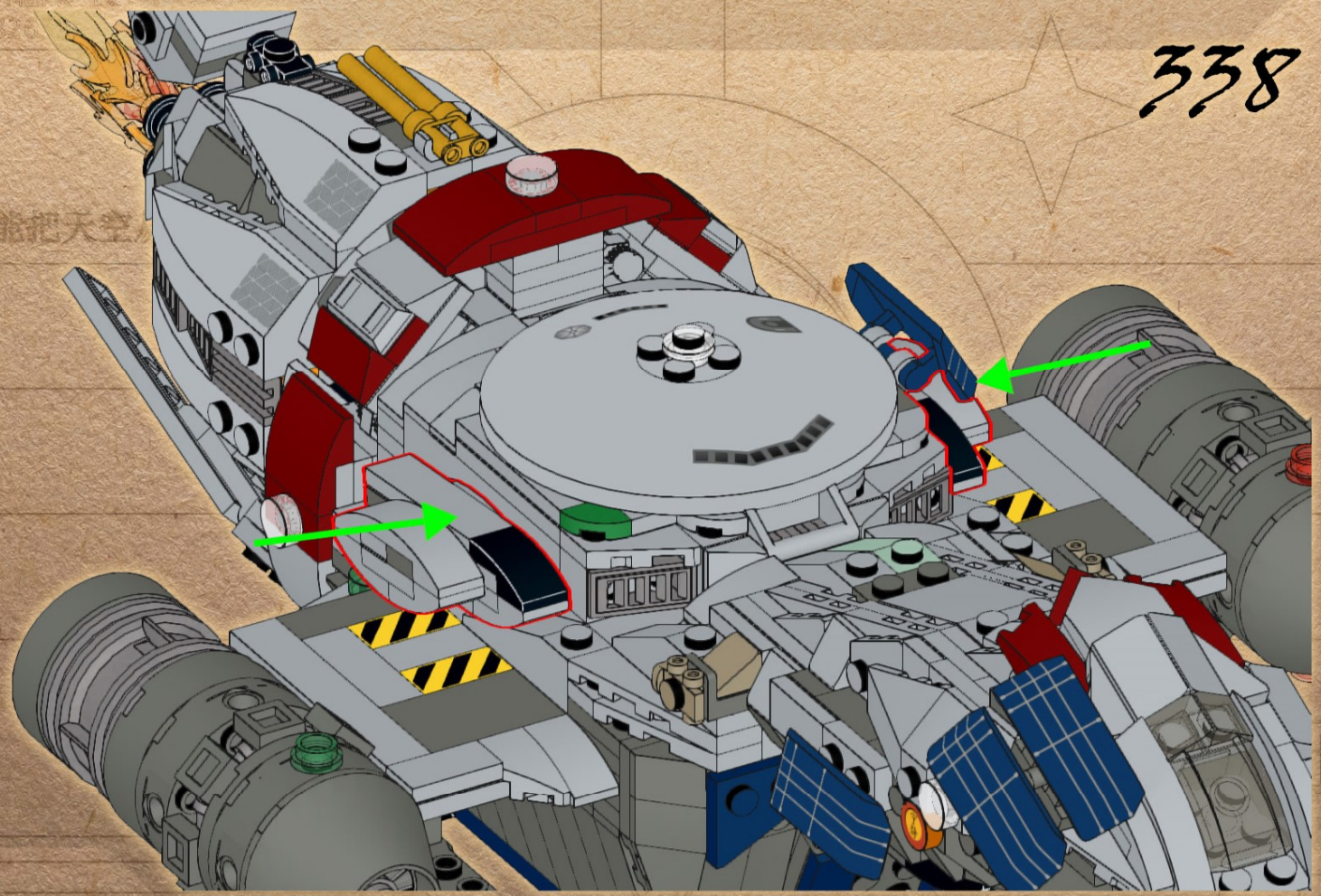

02-404-E-132-4FE274A  
47 Mark IV  
G-87659

不能把天空从我身边带走

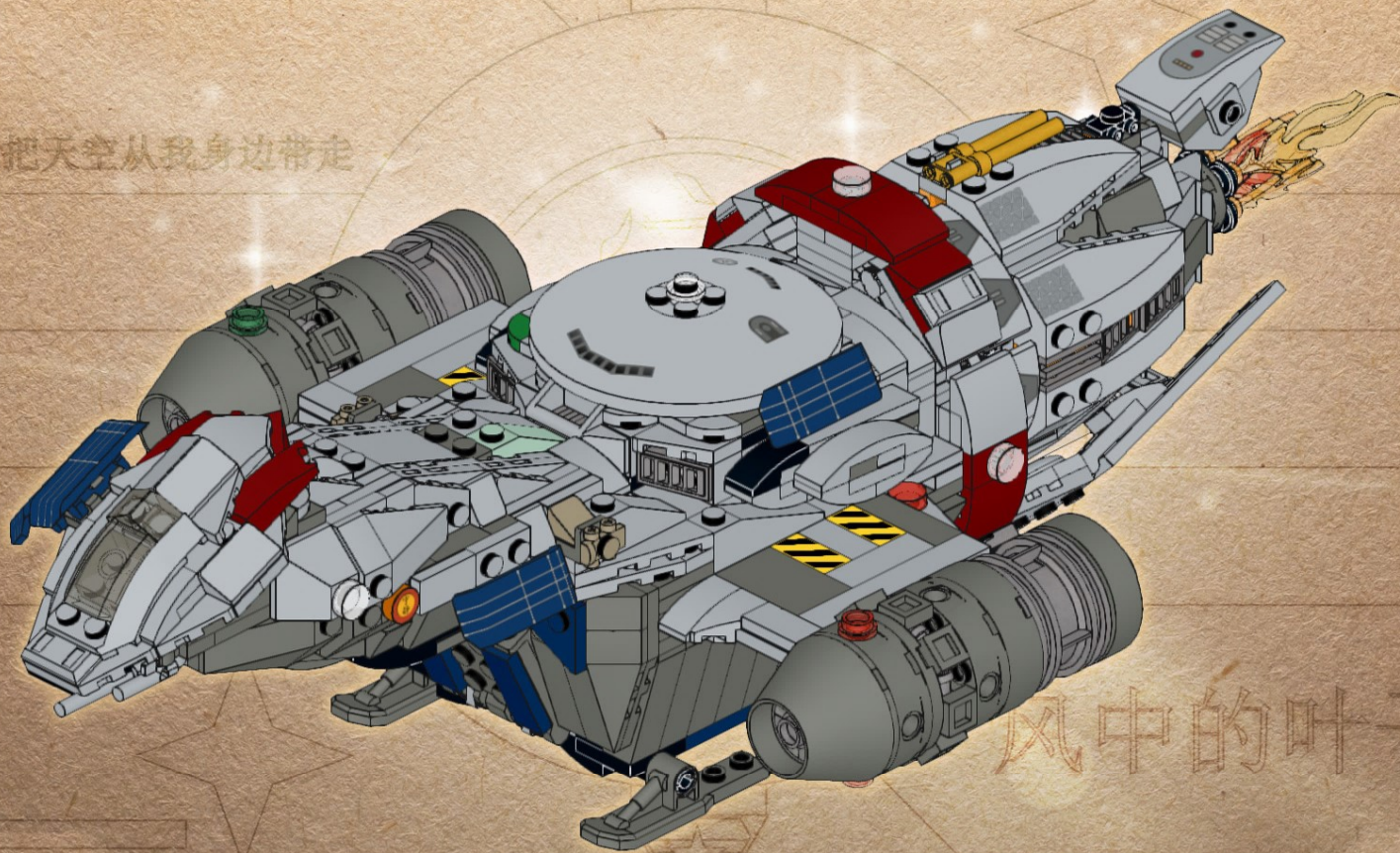

风中的叶子

404-E-132-4FE274A







Parts with  can be of ANY Color!





# MALCOLM "MAL" REYNOLDS

不能把天空从我身边带走

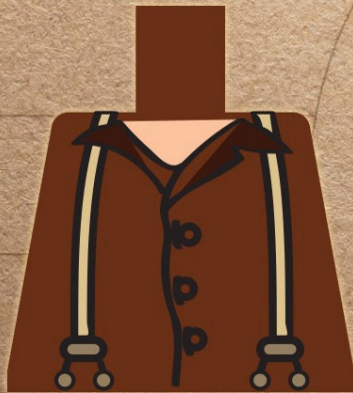

1x  
970c02pb04  
Tan



1x  
3626cpb1782  
Light Nougat



1x  
981  
Reddish Brown



1x  
973  
Reddish Brown



1x  
982  
Reddish Brown



1x  
62810  
Dark Brown



2x  
983  
Dark Brown



1x  
13562  
Flat Silver

风中的叶子



# STICKER SHEET / CUSTOM PRINTS AVAILABLE ON REQUEST

Includes: Ship details, character details, 2x4 tile

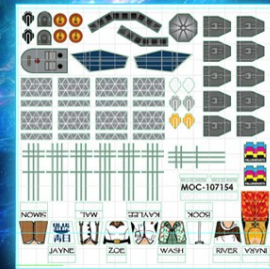

FIREFLY CLASS TRANSPORT  
**SERENITY**  
MOC-107154



[millionprints.com/contact/](https://millionprints.com/contact/)  
**ASK ABOUT MOC-107154**

LEGO® is a trademarks of The LEGO Group of companies which does not sponsor, authorize or endorse the millionprints.com Facebook Page, Web page or Etsy shop. The products seen here are not LEGO® Products. They are re-used LEGO elements that have been modified and repackaged from their original form. The LEGO Group is not liable for any loss, injury or damage arising from the use or misuse of millionprints products.

# SPECIAL THANKS / REMERCIEMENTS



Pierre-Luc Bélanger  
Eloi Parizeau  
Gary Dessureault  
Jenny Flansberry  
Alex "Ironside" Potvin  
Jimmy Desourdis  
James Laroque  
Daniel Couture  
Annie Normandin  
PF Demers



Steven Smyth  
Clark Ashton Smith



Jason Pyett  
David Strenzler  
Paul Lavallée  
Carlos Serratos  
CJ Hendrix  
Nathanaël Kuipers  
Imre Kriston  
Luka Anauldi  
Maria Kalaoglou  
Eric Dubois  
Patrick B



Friends & Family

Stacy Boisvert  
Maxime Dero  
Maxime Chapdelaine  
Maxime Cuerrier  
Marc-André Grenier  
Jean-Philippe Borduas  
Mathieu Gendron Denis  
Jonathan Labrie  
Simon Charron  
Nicolas Sigounis  
Roxanne Ross  
Marc Bobby Wong  
Marie-Pier Contant  
Catherine Thériault  
William Fafard  
Cat Merlini  
Stefanny Fodor  
Roch Magnan  
Sarah Dagar  
Jayson Ng  
Peter Schott  
Andrew Michael



Stach Brickers  
Canada First Bricks  
Onebrick@atime  
Zone Brix  
Life in Plastic  
Dan the Brick Man  
Leopard37  
GTABricks



EpicJasonX9000  
Theodoric



Matt Mitchell



Marc-André Bazergui  
Mimaki-Senpai

Sanji

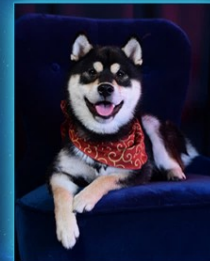

**Martin Beaumont-Pike / Slick\_B175**  
Original creator of MOC-87563

## Software / Tools



